



Austech

I N D U S T R I E S

Air & Powered Equipment Price Catalogue



2010 Austech Price List

www.austechindustries.com.au

Limited Warranty

Austech products are warranted for the period specified below, from date of sale to the original purchaser. This warranty covers faulty workmanship and materials only.

Accessories as pads, blades, retainer springs, chisels, chucks or any other such attachments are not included.

Products which are being claimed for warranty are to be returned to Austech or an appointed warranty agent freight prepaid with your name address, adequate proof of date of purchase and short description of the defect. This warranty does not apply to products which have been abused, misused, modified or repaired by anyone other than an Austech appointed repair agent.

Austech's sole liability under this warranty is limited to the repair or replacement of the defective product. The decision to repair or replace remains solely at the discretion of Austech Industries only and the repairs or replacements are warranted as described above for the remainder of the original warranty.

INFORMATION CHART		
BAR x 14.7	=	PSI
PSI x 0.06895	=	BAR
PSI x 6.895	=	KPA
KG/CM ² x 14.23	=	PSI
CU FT / MIN x 28.32	=	L/MIN
KW x 1.34	=	HORSEPOWER
1 BAR	=	100 KPA

TORINI ENGINES	36 Months (Limited)
SCORPION POWERED EQUIPMENT	12 Months
SCORPION ELECTRIC PRESSURE WASHERS	12 Months
SCORPION WATER PUMPS	12 Months
FINI SCREW COMPRESSORS	12 Months
REFRIGERATED AIR DRYERS	12 Months
SP COMPRESSORS	36 Months
SP AIR TOOLS	12 Months
SCORPION COMPRESSOR PUMPS	
Direct Drive: 8 Bar	12 Months
10 Bar	24 Months
Belt Drive: 8 Bar	12 Months
9 & 10 Bar	36 Months
ALL OTHER SCORPION COMPRESSOR COMPONENTS	12 Months
SCORPION AIR TOOLS	12 Months
SCORPION SPRAY GUNS	12 Months
SCORPION NAIL GUNS	12 Months
SRT COMPRESSORS	12 Months
SRT AIR TOOLS	12 Months

For a complete copy of all warranty terms and conditions please contact Austech Industries, service@austechindustries.com.au

Terms & Conditions

- Prices are subject to change without notice.
- This is a wholesale price list. Prices do not include GST. GST will be charged at the ruling rate which is currently 10%.
- Trading terms are strictly 30 days to established accounts only.
- Title does not pass in goods invoiced until payment is made in full. Claims will not be recognised after 14 days from delivery of goods.
- Returns must first be authorised by our office, freight pre-paid, showing documents with the original invoice number. Returns are subject to a 15% re-stocking fee and will only be accepted if goods are received in an unused and resalable condition.
- There is a minimum invoice value of \$50.00. For details on FIS and freight charges, please contact your Austech office for details.

© COPYRIGHT

Reproduction of this price list whole or in part is prohibited without written approval from Austech Industries P/L.

- ™ **T.M.** Austech logos are registered trade marks and should not be reproduced without written approval from Austech Industries P/L.

CREDIT CARDS

Austech Industries P/L accepts MASTERCARD, BANKCARD and VISA.

If you wish to pay your account by credit card, please contact our office for details of conditions.

Whilst every effort is made to ensure that product and price information is correct at time of print, we reserve the right to correct printing errors.

Contents

Torini
Engines

TORINI 2
ENGINES



Generators &
Workstations

SCORPION 4



Pressure Washers
& Accessories

SCORPION 9



Finis Screw Compressors,
Austech Dryers & Filters

Finis 15



SP Air Compressors,
Tools & Accessories

SP 18
SP AIR



Scorpion Compressors,
Tools & Accessories

SCORPION 44



SRT Compressors,
Tools & Accessories

SRT AIR 71



Merchandisers

76





Now at the heart of the new range of Scorpion Petrol Powered Equipment, Torini Industrial Engines offer a long service life and reliability when you need it most. TORINI "The little Bull" is tough and powerful just like its name, fully backed by a 3 year nationwide manufacturer's warranty.

- Fast starting
- Transistorised ignition
- Smooth operation
- OHV (over head valve)
- High efficiency
- Low oil protection

Meet your expectation with a Torini Engine.

TORINI

ENGINES

3 Year Limited Warranty.



Full parts and service back up
2 Austech Price List, 2010

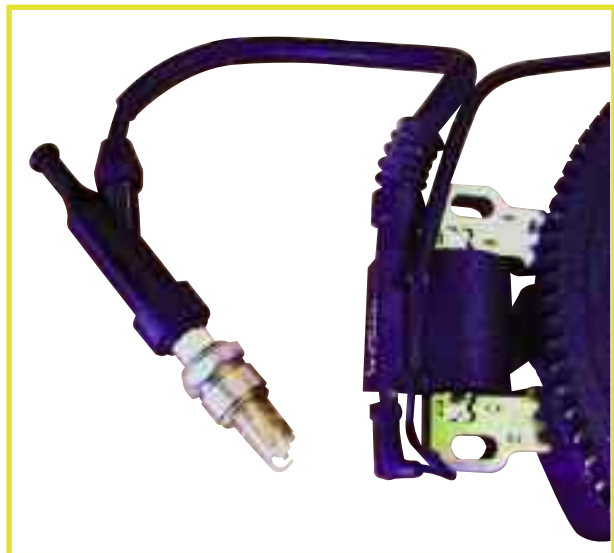

Reliable starting one piece ignition

Torini Engines

Model No.	Barcode	Description/Features	Engine Type	Max Power	Tank Capacity	Price \$
TR200Q	9330514034989	6.5hp Torini Engine	4 Stroke	3.6kw/4000rpm	3.6lt	
TR340QE	9330514035009	11hp Torini Engine with Electric Start	4 Stroke	7.1kw/4000rpm	6.5lt	
TR390QE	9330514035016	13hp Torini Engine with Electric Start	4 Stroke	8.2kw/4000rpm	6.5lt	
TR420QE	9330514035023	15hp Torini Engine with Electric Start	4 Stroke	9kw/4000rpm	6.5lt	

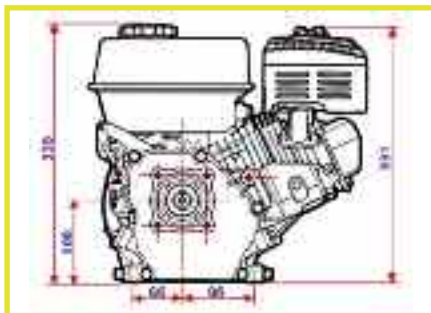

TR200Q/TR210QE



TR340QE



TR390QE



TR420QE



Scorpion Generators are manufactured using the latest technology. At the heart of the new range of Scorpion Generators is the industrial "Torini" engine, offering reliability and long service life when you need it the most.

There are three choices of Alternators: Heavy duty copper, sine wave heavy duty copper and digital inverter.

Scorpion also offers a choice between petrol & diesel, 2-stroke & 4-Stroke motors so that you can choose the unit that is just right for you. Talk to your Scorpion dealer for more information.



Diesel generators

4 Austech Price List, 2010



Digital inverter generators

© Copyright 2010. All prices exclude GST

2hp Portable Generator

Model No.	Barcode	Description/Features	Price \$
SC960	9330514036150	2hp Portable Generator <ul style="list-style-type: none"> • Recoil start • 800w max, 650w rated • 60dB(A) • 2 stroke engine • 50hz/240v • DC: 12v/8.3amp • 4.2lt tank capacity - 6.3 hours • 21kg 	



2.4hp Portable Generator

Model No.	Barcode	Description/Features	Price \$
SC1200	9330514036167	2.4hp Portable Generator <ul style="list-style-type: none"> • Recoil start • 950w max, 850w rated • 63dB(A) • 4 stroke engine • 50hz/240v • DC: 12v/8.3amp • 4.8lt tank capacity - 6 hours • 28kg 	



2hp Pure Sine Wave Generator

Model No.	Barcode	Description/Features	Price \$
PW1000	9330514020395	2hp Pure Sine Wave Generator <ul style="list-style-type: none"> • Recoil start • 1000w max, 900w rated • 60dB(A) • 2 stroke engine • 50hz/240v • 6 hours • 22kg 	



2.5hp Digital Inverter Generator

Model No.	Barcode	Description/Features	Price \$
SDI1000	9330514007730	2.5hp Digital Inverter Generator <ul style="list-style-type: none"> • Recoil start • 1000w max, 900w rated • 58dB(A) • 4 stroke engine • 50hz/240v • DC: 12v/10amp • 2.5lt tank capacity - 5 hours • 13.5kg 	



4.76hp Digital Inverter Generator

Model No.	Barcode	Description/Features	Price \$
SDI2000E	9330514036549	4.76hp Digital Inverter Generator <ul style="list-style-type: none"> • Recoil start • 2200w max, 2000w rated • 58dB(A) • 4 stroke engine • 50hz/240v • DC: 12v/10amp • 2.5lt tank capacity - 5 hours • 28kg 	



6.5hp AVR Generator

Model No.	Barcode	Description/Features	Price \$
SL2800	9330514030585	6.5hp AVR Generator <ul style="list-style-type: none"> • 2.8kva pull start • 2300w max, 2000w rated • 2 power outlets • 50hz/240v • 68dB(A) • 18lt tank capacity 	



6.5hp AVR Generator

Model No.	Barcode	Description/Features	Price \$
SL3500	9330514030592	6.5hp AVR Generator <ul style="list-style-type: none"> • 3.5kva pull start • 2500w max, 2300w rated • 2 power outlets • 50hz/240v • 68dB(A) • 18lt tank capacity 	



11hp AVR Generator

Model No.	Barcode	Description/Features	Price \$
SL5600	9330514030608	11hp AVR Generator <ul style="list-style-type: none"> • 5.6kva pull start • 4500w max, 4000w rated • 3 power outlets • 50hz/240v • 71dB(A) • 25lt tank capacity 	



13hp AVR Generator

Model No.	Barcode	Description/Features	Price \$
SL6800	9330514030615	13hp AVR Generator <ul style="list-style-type: none"> • 6.8kva pull start • 5500w max, 5000w rated • 3 power outlets • 50hz/240v • 72dB(A) • 25lt tank capacity 	



13hp AVR Generator

Model No.	Barcode	Description/Features	Price \$
SL6800E	9330514030622	13hp AVR Generator <ul style="list-style-type: none"> • 6.8kva electric start • 5500w max, 5000w rated • 3 power outlets • 50hz/240v • 72dB(A) • 25lt tank capacity 	



6.5hp AVR Pure Sine Wave Generator

Model No.	Barcode	Description/Features	Price \$
SW2800	9330514030530	6.5hp AVR Pure Sine Wave Generator <ul style="list-style-type: none"> • 2.8kva pull start • 2300w max, 2000w rated • 2 power outlets • 50hz/240v • 68dB(A) • 18lt tank capacity 	



6.5hp AVR Pure Sine Wave Generator

Model No.	Barcode	Description/Features	Price \$
SW3500	9330514036563	6.5hp AVR Pure Sine Wave Generator <ul style="list-style-type: none"> • 3.5kva pull start • 2500w max, 2300w rated • 2 power outlets • 50hz/240v • 68dB(A) • 18lt tank capacity 	



13hp AVR Pure Sine Wave Generator

Model No.	Barcode	Description/Features	Price \$
SW6800	9330514030554	13hp AVR Pure Sine Wave Generator <ul style="list-style-type: none"> • 6.8kva pull start • 5500w max, 5000w rated • 3 power outlets • 50hz/240v • 72dB(A) • 25lt tank capacity 	



13hp AVR Pure Sine Wave Generator

Model No.	Barcode	Description/Features	Price \$
SW6800E	9330514030561	13hp AVR Pure Sine Wave Generator <ul style="list-style-type: none"> • 6.8kva electric start • 5500w max, 5000w rated • 3 power outlets • 50hz/240v • 72dB(A) • 25lt tank capacity 	



15hp AVR Pure Sine Wave Generator

Model No.	Barcode	Description/Features	Price \$
SW8100E	9330514030578	15hp AVR Pure Sine Wave Generator <ul style="list-style-type: none"> • 8.1kva electric start • 6500w max, 6000w rated • 3 power outlets • 50hz/240v • 72dB(A) • 25lt tank capacity 	



Diesel Generators

Model No.	Barcode	Description/Features	Price \$
D4	9330514022757	6.6hp Diesel Generator <ul style="list-style-type: none"> Watts: 3800w max, 2800w rated Silenced: 90dB(A) Motor: 6.6hp diesel KVA: 3.75kva@.8pf DC: 12v/8.3amp 	
D6	9330514022764	10hp Diesel Generator <ul style="list-style-type: none"> Watts: 5500w max, 4600w rated Silenced: 95dB(A) Motor: 10hp diesel KVA: 6.3kva@.8pf DC: 12v/8.3amp 	



Welder Generators

Model No.	Barcode	Description/Features	Price \$
S-3000HM	9330514003992	13hp Welder/Generator <ul style="list-style-type: none"> With 12volt/15amp battery charger Start: Recoil KVA: 7kva Welder: 200amp Weight: 80kg Size: 880mmL x 525mmW x 530mmH 	
S-3000HME	933051400405	13hp Welder/Generator <ul style="list-style-type: none"> With 12volt/15amp battery charger Start: Electric KVA: 7kva Welder: 200amp Weight: 80kg Size: 880mmL x 525mmW x 530mmH 	



Petrol Workstation

Model No.	Barcode	Description/Features	Price \$
S-3600HM	9330514004029	Petrol 4 in 1 Workstation <ul style="list-style-type: none"> Generator, compressor, welder and 12volt/15amp battery charger Generator: Recoil start, 13hp Austech' 7kva Compressor: 2hp direct drive, 10lt tank Welder: 200amp Weight: 120kg Size: 880mmL x 525mmW x 530mmH 	



Diesel Workstation

Model No.	Barcode	Description/Features	Price \$
S-3700HM	9330514006290	Diesel 4 in 1 Workstation <ul style="list-style-type: none"> Generator, compressor, welder and 12volt/15amp battery charger Generator: Recoil and the option of electric start, 10hp Austech, 5kva Compressor: 2hp direct drive, 10lt tank Welder: 180amp Weight: 120kg Size: 880mmL x 525mmW x 600mmH 	





Scorpion has teamed up with world renowned manufacturer Annovi Reverbi to offer the ultimate range of high quality pressure cleaners.

The Italian manufacturer offers a variety of superior functions, even in the smallest for the home handy man. All electric units are equipped with TSS (Throttle Stop System) to ensure a long service life.

The petrol powered units are equipped with TORINI engines to give you ultimate performance (SPW2500P and SPW3600P)

TORINI engines have a 3 year warranty to give you piece of mind when making your purchase decision.

SPW1300P is equipped with a 2-stroke Scorpion engine.

SPW1500P is equipped with a 4-stroke Scorpion engine.



Electric pressure washers



Petrol pressure washers

1300w Pressure Washer

Model No.	Barcode	Description/Features	Price \$
SPW112	9330514022832	1300w Pressure Washer <ul style="list-style-type: none"> • Aluminium pump with stainless plunges • Flow Rate: 6L/min • Max Pressure: 1450psi • Working Pressure: 950psi • 5m hose • Variable fan lance 	



1400w Pressure Washer

Model No.	Barcode	Description/Features	Price \$
SPW141	9330514022849	1400w Pressure Washer <ul style="list-style-type: none"> • Aluminium pump with stainless plunges • Flow Rate: 6.16L/min • Max Pressure: 1600psi • Working Pressure: 1015psi • 5m hose • Variable fan lance 	



1700w Pressure Washer

Model No.	Barcode	Description/Features	Price \$
SPW383	9330514022856	1700w Pressure Washer <ul style="list-style-type: none"> • Aluminium pump with stainless plunges • Flow Rate: 6.16L/min • Max Pressure: 1885psi • Working Pressure: 1450psi • 5.5m hose • Turbo & variable fan lance 	



1800w Pressure Washer

Model No.	Barcode	Description/Features	Price \$
SPW490	9330514030264	1800w Pressure Washer <ul style="list-style-type: none"> • Aluminium pump with stainless plunges • Flow Rate: 7L/min • Max Pressure: 2200psi • Working Pressure: 2060psi • 8m hose • Turbo lance 	



TSS (Throttle Stop System)

- draws water from a bucket (after priming)

Pressure Washer

Model No.	Barcode	Description/Features	Price \$
SPW1300P	9330514033449	2hp Domestic Petrol Pressure Washer <ul style="list-style-type: none"> • Engine: 2 stroke • Aluminium pump • Flow: 5.7L/min • Max Pressure: 1300psi • Working Pressure: 1050psi • 6m hose • Stainless steel lance, interchangeable nozzles • No power required - it's petrol powered 	



2.4hp Pressure Washer

Model No.	Barcode	Description/Features	Price \$
SPW1500P	9330514022191	2.4hp Pressure Washer <ul style="list-style-type: none"> • Engine: 2.4hp OHV Scorpion • Aluminium pump • Flow: 7.7l/min • Max Pressure: 2500psi • Working Pressure: 1300psi • Speed: 3600rpm • 6m hose • Stainless steel lance, interchangeable nozzles 	



5.5hp Pressure Washer

Model No.	Barcode	Description/Features	Price \$
SPW2500P	9330514023952	5.5hp Pressure Washer <ul style="list-style-type: none"> • Engine: 5.5hp OHV Torini • Aluminium/brass pump • Flow: 7.7l/min • Max Pressure: 2500psi • Working Pressure: 2200psi • 6m hose • Stainless steel lance with interchangeable nozzles 	



6.5hp Pressure Washer

Model No.	Barcode	Description/Features	Price \$
SPW3600P	9330514031599	6.5hp Pressure Washer <ul style="list-style-type: none"> • Engine: 6.5hp OHV Torini • Aluminium/brass pump • Flow: 9.5l/min • Max Pressure: 3600psi • Working Pressure: 3200psi • 8m hose • Stainless steel lance with interchangeable nozzles 	



15hp Pressure Washer

Model No.	Barcode	Description/Features	Price \$
SPW4500P	9330514036570	15hp Pressure Washer <ul style="list-style-type: none"> • Engine: 15hp OHV Torini • Aluminium/brass pump (triplex style) • Flow: 18.2l/min • Max Pressure: 4400psi • Working Pressure: 4000psi • 8m hose • Stainless steel lance, interchangeable nozzles • Heavy duty powder coated folding frame 	



Jet Lances

Model No.	Barcode	Description/Features	Suits Models					Price \$			
			SPW112	SPW141	SPW383	SPW490	SPW1300P		SPW1500P	SPW2500P	SPW3600P
LC-5	9330514023693	Variable Fan Jet Lance	X	X							
LC-7	9330514023730	Variable Fan Jet Lance			X						
LC-8	9330514023778	Stainless Steel Lance - (Quick Connect Nozzles)					X	X	X	X	
LC-9	9330514035030	Fan Jet/Detergent Lance					X				



Quick Connect Nozzles

Model No.	Barcode	Description/Features	Suits Models					Price \$			
			SPW112	SPW141	SPW383	SPW490	SPW1300P		SPW1500P	SPW2500P	SPW3600P
NZ-8B	9330514035061	Quick Connect Nozzle (Low Pressure)					X	X	X		
NZ-8R	9330514023822	Quick Connect Nozzle (0 Degree)					X	X	X		
NZ-8Y	9330514035078	Quick Connect Nozzle (15 Degree)					X	X	X		
NZ-8G	9330514035085	Quick Connect Nozzle (25 Degree)					X	X	X		
NZ-8W	9330514035092	Quick Connect Nozzle (40 Degree)					X	X	X		
NZ-10B	9330514036679	Quick Connect Nozzle (Soap)									X
NZ-10R	9330514036686	Quick Connect Nozzle (0 Degree)									X
NZ-10Y	9330514036693	Quick Connect Nozzle (15 Degree)									X
NZ-10G	9330514036709	Quick Connect Nozzle (25 Degree)									X
NZ-10W	9330514036716	Quick Connect Nozzle (40 Degree)									X



Turbo Lances

Model No.	Barcode	Description/Features	Suits Models					Price \$			
			SPW112	SPW141	SPW383	SPW490	SPW1300P		SPW1500P	SPW2500P	SPW3600P
TL-5	9330514023723	Turbo Lance	X	X							
TL-7	9330514023761	Turbo Lance			X						
TL-9	9330514035047	Turbo Lance				X					
TL-10	9330514016893	Turbo Lance					X	X	X	X	



Trigger Guns

Model No.	Barcode	Description/Features	Suits Models					Price \$			
			SPW112	SPW141	SPW383	SPW490	SPW1300P		SPW1500P	SPW2500P	SPW3600P
TRG-5	9330514023709	Trigger Gun (Quick Connect)	X	X							
TRG-7	9330514023747	Trigger Gun (Quick Connect)			X						
TRG-8	9330514023785	Trigger					X	X			
TRG-9	9330514035054	Trigger				X					
TRG-10	9330514006436	Trigger					X	X	X	X	



* Please note that pictures may not represent actual item and are to be used as a guide only

Hoses

Model No.	Barcode	Description/Features	Suits Models							Price \$	
			SPW112	SPW141	SPW383	SPW490	SPW1300P	SPW1500P	SPW2500P		SPW3600P
HS-5	9330514023716	High Pressure Hose	X	X							
HS-7	9330514023754	High Pressure Hose			X						
HS-8	9330514023792	High Pressure Hose					X	X			
HS-9	9330514035115	High Pressure Hose				X					
HS-10-20	9330514022979	High Pressure Hose							X	X	



Pipe Cleaning Kit

Model No.	Barcode	Description/Features	Suits Models							Price \$	
			SPW112	SPW141	SPW383	SPW490	SPW1300P	SPW1500P	SPW2500P		SPW3600P
PCK-10	9330514006405	Pipe Cleaning Kit				X	X	X	X	X	



Hose Joiner

Model No.	Barcode	Description/Features	Suits Models							Price \$	
			SPW112	SPW141	SPW383	SPW490	SPW1300P	SPW1500P	SPW2500P		SPW3600P
HS-10C	9330514028506	Hose Joiner (Suit HS-10-20)							X	X	



Brushes

Model No.	Barcode	Description/Features	Suits Models							Price \$	
			SPW112	SPW141	SPW383	SPW490	SPW1300P	SPW1500P	SPW2500P		SPW3600P
FB-7	9330514035108	Fixed Brush	X	X	X						
FB-10	9330514006382	Fixed Brush				X	X	X	X	X	
RB-10	9330514006399	Rotary Brush (Pressure Driven)				X	X	X	X	X	



Detergent Bottle

Model No.	Barcode	Description/Features	Suits Models							Price \$	
			SPW-2	SPW112	SPW141	SPW383	SPW490	SPW1300P	SPW1500P		SPW2500P
DN-6	9330514006375	Detergent Applicator	X								
DN-8	9330514035122	Detergent Applicator						X	X	X	X



* Please note that pictures may not represent actual item and are to be used as a guide only

© Copyright 2010. All prices exclude GST

5.5hp Petrol High Pressure Water Pump

Model No.	Barcode	Description/Features	Price \$
SWP200	9330514032084	5.5hp Petrol High Pressure Water Pump <ul style="list-style-type: none"> • Stroke: OHV 4 Stroke • Max Flow: 300L/min • Max Suction Lift: 6m • Max Head to: 42m • Inlet Size: 1.5" • Outlet Size: 1x1.5" or 2x1" • 25kg 	



TOPINI
ENGINES

Hose Kit

Model No.	Barcode	Description/Features	Price \$
BFKN	9330514012444	Hose Kit <ul style="list-style-type: none"> • 40mm x 5m medium duty spiral PVC suction hose with poly strainer • 20mm x 15m PVC water hose with adjustable nozzle 	





Finis Screw Compressors have been designed for reliability and efficiency, optimizing energy consumption, operation and maintenance costs.

New construction based on integrating several components in the main body optimises the reliability & performance of the Compressor.

Austech Dryers have high quality refrigeration controls to produce consistent cooling temperatures over a wide range of flow and operating conditions.

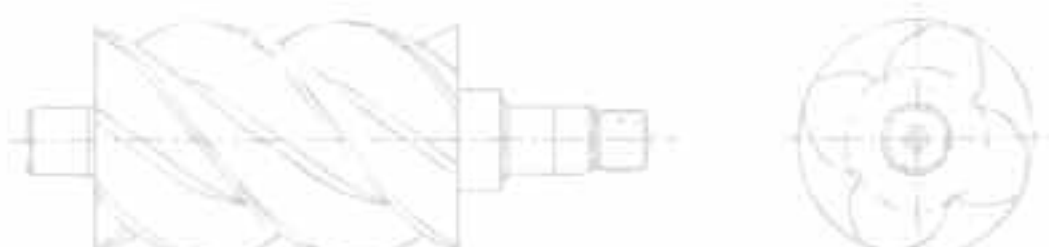

Easy maintenance

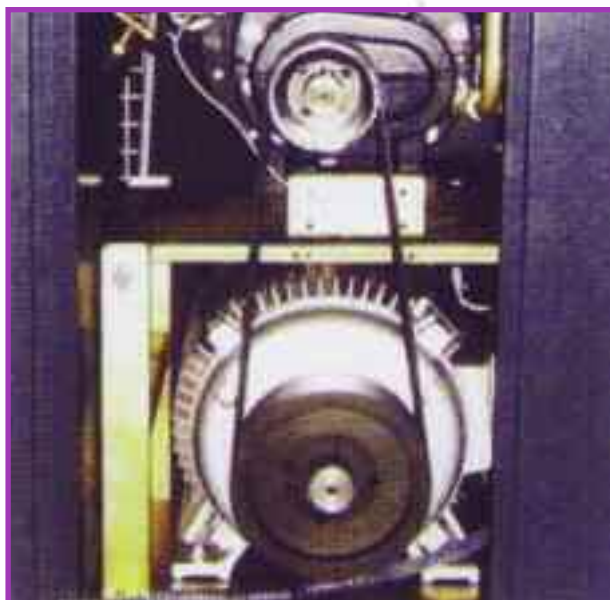

Reliable transmission

Finì Screw Compressors

Model No.	Barcode	Description/Features	Price \$
BSC10270L	9330514035146	10hp Finì Screw Compressor	
BSC15270L	9330514035153	15hp Finì Screw Compressor	
BSC20270L	9330514035160	20hp Finì Screw Compressor	
		<ul style="list-style-type: none"> • Low noise output • Easy "Tronic" controller • Plug and play • Includes air receiver tank (270lt) 	



Designed, manufactured and assembled entirely in the FINI Italian facilities



"Spin-on" oil filter, programmed maintenance, simple, quick and economical



Finì Screw Compressors

Model No.	Barcode	Description/Features	Price \$
PLUS30	9330514035177	30hp Finì Screw Compressor	
		<ul style="list-style-type: none"> • Compact and silent • Easy "Tronic" controller • Control of the working pressure with transducer 	



Easy "Tronic" electronic controller

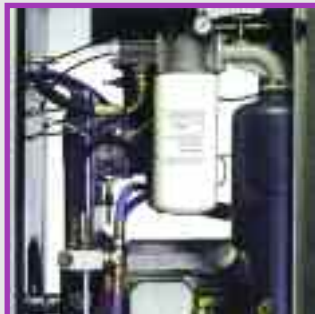

"Spin-on" oil filter, programmed maintenance, simple, quick and economical



Finì Screw Compressors

Model No.	Barcode	Description/Features	Price \$
MCi40	9330514035184	40hp Finì Screw Compressor	
MCi50	9330514035191	50hp Finì Screw Compressor	



The heart of the MCi line including oil separator tank and filler thermostatic valve, minimum pressure valve - aspiration regulator



Reliable transmission, spax belts and automatic tensioner



Austech Dryers & Filters

700L/min Air Dryer

Model No.	Barcode	Description/Features	Price \$
LD05SHA	9330514007099	25scfm Air Dryer <ul style="list-style-type: none"> • Max Air Flow: 700L/min • Inlet Temp: 80°C • Ambient Temp: <38°C • Max Pressure: 150psi • Voltage: 10amp/240volt • Inlet: 1/2" BSP • HxWxD: 470 x 400 x 400mm 	



1350L/min to 7000L/min Air Dryers

Model No.	Barcode	Description/Features	Price \$
LD10SHA	9330514007105	47scfm Air Dryer <ul style="list-style-type: none"> • Inlet: 3/4" BSP • Max Air Flow: 1350L/min 	
LD15SHA	9330514007235	61scfm Air Dryer <ul style="list-style-type: none"> • Inlet: 3/4" BSP • Max Air Flow: 1800L/min 	
LD20SHA	9330514007112	95scfm Air Dryer <ul style="list-style-type: none"> • Inlet: 1" BSP • Max Air Flow: 2800L/min 	
LD50SHA	9330514008041	238scfm Air Dryer <ul style="list-style-type: none"> • Inlet: 2" BSP • Max Air Flow: 6750L/min All Air Dryers: <ul style="list-style-type: none"> • Max Inlet Temp: 80°C • Ambient Temp: <38°C • Max Pressure: 150psi • Voltage: 10amp/240volt • Auto drain 	



Pre Filters

Model No.	Barcode	Description/Features	Price \$
JF-C-001	9330514006696	Pre-filter 5 Micron <52cfm	
JF-C-002	9330514006702	Pre-filter 5 Micron <88cfm	
JF-C-007	9330514006719	Pre-filter 5 Micron <245cfm <ul style="list-style-type: none"> • Includes auto drain 	



Post Filters

Model No.	Barcode	Description/Features	Price \$
JF-A-001	9330514006726	Post-filter 0.01 Micron <52cfm	
JF-A-002	9330514006733	Post-filter 0.01 Micron <88cfm	
JF-A-007	9330514006740	Post-filter 0.01 Micron <245cfm	





SP Professional Tools and Compressors are renowned for their range, quality and innovation in air operated products.



With over 32 years of experience and many of our patented designs created in-house, you can always trust SP Professional Tools.

- The world's finest automotive impact wrenches
- Ratchets with induction hardened heads to minimise the risk of spreading
- Latest technology bodies – low weight – high strength
- SP Air Tools satisfy the requirements of EC Machine Directives (89/392 EEC, 91/368/EC)

SP Construction Series Compressors and Nailers are designed for Australian construction sites – tough and lightweight to handle any demand.

- Compressors all run on 10amp outlets
- Unloading valve for easy start up
- 10 bar pressure for operating nailing equipment
- 3 year industrial warranty



Construction compressors



Construction nailers

2hp Trade Duty Portable Air Compressor

Model No.	Barcode	Description/Features	Price \$
SP11-10	9330514030219	2hp Trade Duty Portable Air Compressor <ul style="list-style-type: none"> • Direct drive • 125psi • Regulator • 10lt tank • 10amp/240volt • FAD 131L/min 	

2hp Portable Air Compressor

Model No.	Barcode	Description/Features	Price \$
SP11-40	9330514030226	2hp Portable Air Compressor <ul style="list-style-type: none"> • Direct drive • 136psi • Filter/regulator • 36lt tank • 10amp/240volt • FAD 127L/min 	

2.5hp Portable Air Compressor

Model No.	Barcode	Description/Features	Price \$
SP12-50	9330514030240	2.5hp Portable Air Compressor <ul style="list-style-type: none"> • Direct drive • 150psi • Filter/regulator • 50lt tank • 10amp/240volt • FAD 170L/min 	

2.2hp Cast Iron V-Twin Portable Air Compressor

Model No.	Barcode	Description/Features	Price \$
SP13-50	9330514030257	2.2hp Cast Iron V-Twin Portable Air Compressor <ul style="list-style-type: none"> • Belt drive • 150psi • Filter/regulator • 50lt tank • 10amp/240volt • FAD 186L/min 	



SP Air 22 Gauge Construction Series Stapler

Model No.	Barcode	Description/Features	Price \$
SP-9171	9330514036372	SP Air 22 Gauge Construction Series Stapler <ul style="list-style-type: none"> • 22 Ga staples with 9mm crown • Load capacity 180pc 6-16mm • Fast top loading magazine • Light die cast aluminum body reduces working fatigue • Adjustable exhaust 	



SP Air 21 Gauge Construction Series Stapler

Model No.	Barcode	Description/Features	Price \$
SP-9180	9330514036389	SP Air 21 Gauge Construction Series Stapler <ul style="list-style-type: none"> • 21 Ga staples with 12.7mm crown • Load capacity 150pc 6-16mm • Fast top loading magazine • Light die cast aluminum body reduces working fatigue • Adjustable exhaust 	



SP Air 18 Gauge Construction Series Stapler

Model No.	Barcode	Description/Features	Price \$
SP-9190	9330514036402	SP Air 18 Gauge Construction Series Stapler <ul style="list-style-type: none"> • 18 Ga staples with 5.7mm crown • Load capacity 100pc 16-40mm • Fast top loading magazine • Light die cast aluminum body reduces working fatigue • Adjustable exhaust 	



SP Air 18 Gauge Construction Series C1 Bradder

Model No.	Barcode	Description/Features	Price \$
SP-9215	9330514036396	SP Air 16 Gauge Construction Series C1 Bradder <ul style="list-style-type: none"> • 18 Ga C1 brads • Load capacity 100pc 20-50mm • Fast top loading magazine • Light die cast aluminum body reduces working fatigue • Adjustable exhaust 	



SP Air 16 Gauge Construction Series C Bradder

Model No.	Barcode	Description/Features	Price \$
SP-9225	9330514036426	SP Air 16 Gauge Construction Series C Bradder <ul style="list-style-type: none"> • 16 Ga C brads • Load capacity 80pc 20-50mm • Fast top loading magazine • Light die cast aluminum body reduces working fatigue • Adjustable exhaust 	



SP Air Construction Series Flooring Stapler/Nailer

Model No.	Barcode	Description/Features	Price \$
SP-9200	9330514030271	<p>SP Air Construction Series Flooring Stapler/Nailer</p> <ul style="list-style-type: none"> • 15-1/2 Ga 92pc staples and 16Ga 100pc "L" cleat load capacity • Light cast aluminium body • Rubber wrapped handle, comfortable for use • 360° adjustable exhaust deflector • Innovative 2 in magazine design for staple and cleat nail • Good balance • Mallet included 	



SP Air Construction Series Angle Finish Nailer

Model No.	Barcode	Description/Features	Price \$
SP-9250	9330514030288	<p>SP Air Construction Series Angle Finish Nailer</p> <ul style="list-style-type: none"> • Uses 15Ga angle finish nails from 1-1/4" to 2-1/2" • Angled magazine • Hard coat anodized aluminium magazine holds 100 nails at one time • Adjustable depth of drive for precision nailing • Quick-release nosepiece for fast clearing of jams • No mar rubber safety tip • Muffled 360° adjustable exhaust port 	



SP Air Construction Series Framing Gun

Model No.	Barcode	Description/Features	Price \$
SP-9350	9330514030295	<p>SP Air Construction Series Framing Gun</p> <ul style="list-style-type: none"> • Load capacity 80pcs • Cast magnesium alloy body • Fast top loading magazine • Long, narrow nose piece • High power and fast cycle rate • Adjustable exhaust deflector • Comfortable rubber grip • Non slip safety cone • Excellent manoeuvrability and line of sight • Fold away rafter hanger 	



SP Air Construction Series Coil Nailer

Model No.	Barcode	Description/Features	Price \$
SP-9660	9330514030301	<p>SP Air Construction Series Coil Nailer</p> <ul style="list-style-type: none"> • 200-300pc load capacity • Drives standard coil wire/plastic sheet collation nails from 1-12" to 2-1/2" x .090 to .099 • Strong and light die cast magnesium alloy body • Speed nailing performance • Depth of drive quick-adjustment to countersink or flush drive nails • No-mark contact tip included 	



3/8" Mini Ratchet Wrench - Rotary Head

Model No.	Barcode	Description/Features	Price \$
SP-7742RH	4545695001544	3/8" Mini Ratchet Wrench with Rotary Head <ul style="list-style-type: none"> • 125mm long • 310rpm • 8mm capacity • 485L/min max, 146L/min av air consumption • 5-24ft/lbs hand torque 	



3/8" Mini Ratchet Wrench - Rotary Head

Model No.	Barcode	Description/Features	Price \$
SP-1772	4545695001438	3/8" Mini Ratchet Wrench with Rotary Head <ul style="list-style-type: none"> • 170mm long • 310rpm • 10mm capacity • 485L/min max, 146L/min av air consumption • 40ft/lbs hand torque 	



3/8" Mini Ratchet Wrench - Sealed Head

Model No.	Barcode	Description/Features	Price \$
SP-7255	4545695001315	3/8" Mini Ratchet Wrench with Sealed Head <ul style="list-style-type: none"> • 200mm long • 250rpm • 10mm capacity • 500L/min max, 150L/min av air consumption • 40ft/lbs hand torque 	



1/4" Mini Ratchet Wrench

Model No.	Barcode	Description/Features	Price \$
SP-1760A	4545695000028	1/4" Mini Ratchet Wrench <ul style="list-style-type: none"> • 170mm long • 310rpm • 10mm capacity • 485L/min max, 146L/min av air consumption • 40ft/lbs hand torque 	



3/8" Mini Ratchet Wrench

Model No.	Barcode	Description/Features	Price \$
SP-1762	4545695000011	3/8" Mini Ratchet Wrench <ul style="list-style-type: none"> • 170mm long • 310rpm • 10mm capacity • 485L/min max, 146L/min av air consumption • 40ft/lbs hand torque 	



SP Ratchet Wrenches have an induction hardened ratchet head which minimises the risk of spreading and lessens the likelihood of loss of power.



Impact mechanism

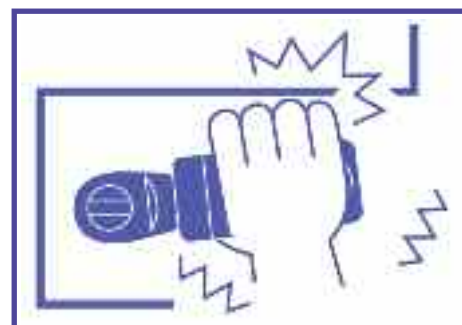

Reactionless



SP Mini Ratchets are compact and lightweight and are ideal for hard to reach areas. They have ball type retainers for positive socket retention and rear exhausts.

3/8" Mini Impact Ratchet Wrench

Model No.	Barcode	Description/Features	Price \$
SP-1765	4545695002015	3/8" Mini Impact Ratchet Wrench • 178mm long • 500rpm • 10mm capacity • 396L/min max air consumption • 35ft/lbs max torque	

3/8" Ratchet Wrench

Model No.	Barcode	Description/Features	Price \$
SP-1133SX	4545695000562	3/8" Ratchet Wrench <ul style="list-style-type: none"> • 254mm long • 160rpm • 10mm capacity • 525L/min max, 158L/min av air consumption • 124ft/lbs hand torque 	



1/2" Ratchet Wrench

Model No.	Barcode	Description/Features	Price \$
SP-1133SX-2	4545695000562	1/2" Ratchet Wrench <ul style="list-style-type: none"> • 254mm long • 160rpm • 12mm capacity • 525L/min max, 158L/min av air consumption • 124ft/lbs hand torque 	



1/2" Ratchet Wrench

Model No.	Barcode	Description/Features	Price \$
SP-7131	4545695001216	1/2" Ratchet Wrench <ul style="list-style-type: none"> • 270mm long • 180rpm • 12mm capacity • 540L/min max, 165L/min av air consumption • 135ft/lbs hand torque 	



The SP-7131 comes with an ergonomic polymer grip. It also has a larger motor producing higher torque and a 360 degree air inlet swivel. It has an adjustable rear exhaust.

SP Ratchet Wrenches have an induction hardened ratchet head which minimises the risk of spreading and lessens the likelihood of loss of power.

SP Air Ratchets are tested in accordance with ISO Standards 2787, 8662 and 3744. If you want to increase the life of your air ratchet, do the initial loosening and final tightening of a bolt by hand. You can use your air ratchet as a hand ratchet but the key is don't ask anymore of it than you would a normal hand ratchet. If a hand ratchet won't undo it, then neither will your air ratchet.

SP Air Impact Wrenches 3/8" Dr



3/8" Impact Wrench

Model No.	Barcode	Description/Features	Price \$
SP-1850	4545695001353	3/8" Impact Wrench <ul style="list-style-type: none"> • 137mm long • 0.46kg • 10mm capacity • 264L/min max, 132L/min av air consumption • 60ft/lbs max torque 	



3/8" Impact Wrench

Model No.	Barcode	Description/Features	Price \$
SP-1826	4545695000134	3/8" Impact Wrench <ul style="list-style-type: none"> • 120mm long • 0.80kg • 12mm capacity • 394L/min max, 197L/min av air consumption • 70ft/lbs max torque 	



3/8" Impact Wrench

Model No.	Barcode	Description/Features	Price \$
SP-2136	9330514006467	3/8" Impact Wrench <ul style="list-style-type: none"> • 155mm long • 0.94kg • 12mm capacity • 485L/min max, 146L/min av air consumption • 100ft/lbs max torque 	



3/8" Impact Wrench

Model No.	Barcode	Description/Features	Price \$
SP-2135	9330514006450	3/8" Impact Wrench <ul style="list-style-type: none"> • 140mm long • 1.16kg • 12mm capacity • 525L/min max, 158L/min av air consumption • 125ft/lbs max torque 	



3/8" Impact Wrench

Model No.	Barcode	Description/Features	Price \$
SP-7825	4545695001735	3/8" Impact Wrench <ul style="list-style-type: none"> • 110mm long • 0.68kg • 12mm capacity • 468L/min max, 140L/min av air consumption • 60ft/lbs max torque 	



SP Air Impact Wrenches 1/2" Dr



1/2" Impact Wrench

Model No.	Barcode	Description/Features	Price \$
SP-1144EX	4545695001995	1/2" Impact Wrench • 163mm long • 1.54kg • 16mm capacity • 635L/min max, 190L/min av air consumption • 350ft/lbs max torque	



1/2" Impact Wrench

Model No.	Barcode	Description/Features	Price \$
SP-1145A	4545695000004	1/2" Impact Wrench • 190mm long • 2.5kg • 16mm capacity • 808L/min max, 242L/min av air consumption • 425ft/lbs max torque	



1/2" Impact Wrench

Model No.	Barcode	Description/Features	Price \$
SP-1145C	4545695001223	1/2" Impact Wrench • 200mm long • 2.24kg • 16mm capacity • 870L/min max, 261L/min av air consumption • 500ft/lbs max torque	

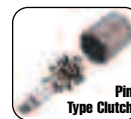

1/2" Impact Wrench

Model No.	Barcode	Description/Features	Price \$
SP-1145L	4545695001940	1/2" Impact Wrench • 230mm long • 2.6kg • 16mm capacity • 808L/min max, 242L/min av air consumption • 425ft/lbs max torque • Includes 2 x flip sockets 17x19mm & 21x22mm	



1/2" Impact Wrench

Model No.	Barcode	Description/Features	Price \$
SP-1140EX	4545695000189	1/2" Impact Wrench <ul style="list-style-type: none"> • 185mm long • 2.58kg • 16mm capacity • 870L/min max, 261L/min av air consumption • 600ft/lbs max torque 	



1/2" Impact Wrench

Model No.	Barcode	Description/Features	Price \$
SP-1140EXL	4545695000193	1/2" Impact Wrench <ul style="list-style-type: none"> • 240mm long • 2.6kg • 16mm capacity • 870L/min max, 261L/min av air consumption • 600ft/lbs max torque 	



1/2" Impact Wrench

Model No.	Barcode	Description/Features	Price \$
SP-7140	4545695000158	1/2" Impact Wrench <ul style="list-style-type: none"> • 185mm long • 2.1kg • 16mm capacity • 870L/min max, 261L/min av air consumption • 580ft/lbs max torque 	



1/2" Impact Wrench

Model No.	Barcode	Description/Features	Price \$
SP-7145	4545695000208	1/2" Impact Wrench <ul style="list-style-type: none"> • 167mm • 1.9kg • 16mm • 870L/min max, 261L/min av air consumption • 780ft/lbs max torque 	



SP Air Impact Wrenches 3/4" Dr



3/4" Impact Wrench

Model No.	Barcode	Description/Features	Price \$
SP-1156TR	4545695000202	3/4" Impact Wrench <ul style="list-style-type: none"> • 280mm long • 5.4kg • 25mm capacity • 971L/min max, 291L/min av air consumption • 950ft/lbs max torque 	



3/4" Impact Wrench

Model No.	Barcode	Description/Features	Price \$
SP-1158	4545695001001	3/4" Impact Wrench <ul style="list-style-type: none"> • 220mm long • 5.5kg • 25mm capacity • 1080L/min max, 324L/min av air consumption • 1100ft/lbs max torque 	



3/4" Impact Wrench

Model No.	Barcode	Description/Features	Price \$
SP-1158L	4545695001292	3/4" Impact Wrench <ul style="list-style-type: none"> • 380mm long • 6.5kg • 25mm capacity • 1080L/min max, 324L/min av air consumption • 1100ft/lbs max torque 	

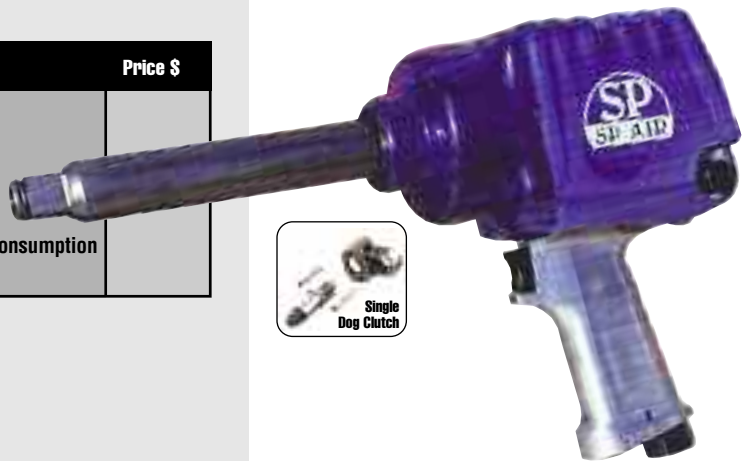

3/4" Impact Wrench

Model No.	Barcode	Description/Features	Price \$
SP-7151	4545695001865	3/4" Impact Wrench <ul style="list-style-type: none"> • 269mm long • 4.27kg • 25mm capacity • 971L/min max, 291L/min av air consumption • 1290ft/lbs max torque 	

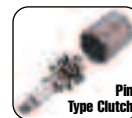

1" Impact Wrench

Model No.	Barcode	Description/Features	Price \$
SP-1190P	4545695001018	1" Impact Wrench <ul style="list-style-type: none"> • 250mm long • 9kg • 38mm capacity • 1130L/min max, 339L/min av air consumption • 1800ft/lbs max torque 	



1" Impact Wrench

Model No.	Barcode	Description/Features	Price \$
SP-1190-2	4545695001179	1" Impact Wrench <ul style="list-style-type: none"> • 330mm long • 8.7kg • 45mm capacity • 1130L/min max, 339L/min av air consumption • 2200ft/lbs max torque 	



1" Impact Wrench

Model No.	Barcode	Description/Features	Price \$
SP-1190-6	4545695001339	1" Impact Wrench <ul style="list-style-type: none"> • 430mm long • 9.2kg • 45mm capacity • 1130L/min max, 339L/min av air consumption • 2200ft/lbs max torque 	



1" Impact Wrench

Model No.	Barcode	Description/Features	Price \$
SP-1190-8	4545695001308	1" Impact Wrench <ul style="list-style-type: none"> • 430mm long • 9.5kg • 45mm capacity • 1130L/min max, 339L/min av air consumption • 2200ft/lbs max torque 	



1" Impact Wrench

Model No.	Barcode	Description/Features	Price \$
SP-1192EX-2	4545695001230	1" Impact Wrench <ul style="list-style-type: none"> • 360mm long • 6.45kg • 38mm capacity • 1130L/min max, 339L/min av air consumption • 1330ft/lbs max torque 	



1" Impact Wrench

Model No.	Barcode	Description/Features	Price \$
SP-1192EX-6	4545695001247	1" Impact Wrench <ul style="list-style-type: none"> • 511mm long • 7.35kg • 38mm capacity • 1130L/min max, 339L/min av air consumption • 1330ft/lbs max torque 	



1/4" Straight Die Grinder

Model No.	Barcode	Description/Features	Price \$
SP-7200	4545695000332	1/4" Straight Die Grinder <ul style="list-style-type: none"> • 153mm long • 23000rpm • 6.35mm capacity • 500L/min max, 350L/min av air consumption • 0.41kg 	



1/4" Straight Die Grinder

Model No.	Barcode	Description/Features	Price \$
SP-1210	4545695001070	1/4" Straight Die Grinder <ul style="list-style-type: none"> • 145mm long • 23000rpm • 6.35mm capacity • 603L/min max, 422L/min av air consumption • 0.54kg 	



1/4" Straight Die Grinder

Model No.	Barcode	Description/Features	Price \$
SP-2200	9330514006528	1/4" Straight Die Grinder <ul style="list-style-type: none"> • 120mm long • 28000rpm • 6.35mm capacity • 465L/min max, 326L/min av air consumption • 0.32kg 	



SP Die Grinders can be used in a wide range of applications such as gasket & silicone removal from heads, blocks, thermostat housings and water pumps to engine porting including intake manifolds, cylinder heads and exhaust manifolds as well as a wide range of deburring and grinding applications using stones and carbide burrs.



SP carbide burrs available on page 44

1/4" Angle Die Grinder

Model No.	Barcode	Description/Features	Price \$
SP-7202	4545695000356	1/4", 120° Angle Die Grinder <ul style="list-style-type: none"> • 194mm long • 20000rpm • 6.35mm capacity • 505L/min max, 353L/min av air consumption • 0.56kg 	



1/4" Angle Die Grinder

Model No.	Barcode	Description/Features	Price \$
SP-7201	4545695000349	1/4" 90° Angle Die Grinder <ul style="list-style-type: none"> • 160mm long • 20000rpm • 6.35mm capacity • 505L/min max, 354L/min av air consumption • 0.55kg 	



1/4" Angle Die Grinder

Model No.	Barcode	Description/Features	Price \$
SP-2200AH	9330514006535	1/4" 90° Angle Die Grinder <ul style="list-style-type: none"> • 160mm long • 21000rpm • 6.35mm capacity • 506L/min max, 354L/min av air consumption • 0.56kg 	



1/4" Angle Die Grinder

Model No.	Barcode	Description/Features	Price \$
SP-1207AH	4545695000301	1/4" 120° Angle Die Grinder <ul style="list-style-type: none"> • 155mm long • 21000rpm • 6.35mm capacity • 506L/min max, 354L/min av air consumption • 0.45kg 	



The Seven Series Die Grinders come with an ergonomic polymer grip. Built in power regulator. 360 degree swivel air inlet and adjustable rear exhaust. They are the latest in high performance industrial die grinders.



Safety lever



Regulator



Rear exhaust

SP Air Reversible Pistol Drills



3/8" Pistol Drill (Automotive)

Model No.	Barcode	Description/Features	Price \$
SP-2525	9330514006481	3/8" Pistol Drill <ul style="list-style-type: none"> • 180mm long • 2000rpm • 9.5mm capacity • 546L/min max, 382L/min av air consumption • 1.22kg • Forward/reverse 	



1/2" Pistol Drill (Automotive)

Model No.	Barcode	Description/Features	Price \$
SP-2527	9330514006498	1/2" Pistol Drill <ul style="list-style-type: none"> • 195mm long • 800rpm • 12.7mm capacity • 546L/min max, 382L/min av air consumption • 1.72kg • Forward/reverse 	



3/8" Pistol Drill (Industrial)

Model No.	Barcode	Description/Features	Price \$
SP-1525	4545695000400	3/8" Pistol Drill <ul style="list-style-type: none"> • 195mm long • 2200rpm • 9.5mm capacity • 546L/min max, 382L/min av air consumption • 1.2kg • Forward/reverse 	



3/8" Pistol Drill (Industrial)

Model No.	Barcode	Description/Features	Price \$
SP-1527	4545695000417	1/2" Pistol Drill <ul style="list-style-type: none"> • 220mm long • 500rpm • 12.7mm capacity • 546L/min max, 382L/min av air consumption • 1.58kg • Forward/reverse 	



The SP range of Reversible Drills come with trigger mounted levers. They are lightweight and compact in design. They have heavy duty reduction planetary gears and a positive action trigger for variable speed control.



Reverse lever



Quality chuck



Side handle on slow revving models

3/8" Composite Reversible Drill

Model No.	Barcode	Description/Features	Price \$
SP-7525KL	4545695001780	3/8" Keyless Composite Reversible Drill <ul style="list-style-type: none"> • 155mm long • 2000rpm • 9.5mm capacity • 606L/min max, 424L/min av air consumption • 0.95kg • Forward/reverse 	



1/2" Composite Reversible Drill

Model No.	Barcode	Description/Features	Price \$
SP-7527KL	4545695001797	1/2" Keyless Composite Reversible Drill <ul style="list-style-type: none"> • 180mm long • 380rpm • 12.7mm capacity • 606L/min max, 424L/min av air consumption • 1.30kg • Forward/reverse 	



The SP range of Composite Body Reversible Drills come with one hand reverse button. They are lightweight and come with a keyless chuck.



Composite body



Keyless chuck

3/8" Drill

Model No.	Barcode	Description/Features	Price \$
SP-1511	4545695000370	3/8" Drill <ul style="list-style-type: none"> • 152mm long • 2500rpm • 9.5mm capacity • 465L/min max, 325L/min av air consumption • 0.74kg 	



3/8" Silenced Drill

Model No.	Barcode	Description/Features	Price \$
SP-1522	4545695000387	3/8" Drill <ul style="list-style-type: none"> • 175mm long • 2500rpm • 9.5mm capacity • 548L/min max, 382L/min av air consumption • 0.96kg • Exhaust silencer 	



3/8" 4 Speed Drill

Model No.	Barcode	Description/Features	Price \$
SP-1540	4545695000424	3/8" Drill <ul style="list-style-type: none"> • 180mm long • Variable speed (2200>3000rpm) • 9.5mm capacity • 546L/min max, 382L/min av air consumption • 0.98kg 	



3/8" 90° Angle Drill

Model No.	Barcode	Description/Features	Price \$
SP-1510AH	4545695000363	3/8" Drill <ul style="list-style-type: none"> • 208mm long • 1800rpm • 9.5mm capacity • 485L/min max, 340L/min av air consumption • 1.19kg • Forward/reverse 	



SP-1511 - Compact, lightweight pistol drill

SP-1522 - Industrial duty and silenced

SP-1540 - 4 speed, from 2200-3000rpm

SP-1510AH - Angle head, reversible, precision engineered



Silencer - Model SP-1522



Quality chuck

1/4" Screwgun

Model No.	Barcode	Description/Features	Price \$
SP-1800	4545695000950	1/4" Screwgun • 254mm long • 1800rpm • 6.35mm capacity • 304L/min max, 213L/min av air consumption • 1.1kg	



1/4" Screwgun

Model No.	Barcode	Description/Features	Price \$
SP-1810	4545695000967	1/4" Screwgun • 205mm long • 1800rpm • 6.35mm capacity • 304L/min max, 213L/min av air consumption • 1.2kg	



1/4" Screwgun

Model No.	Barcode	Description/Features	Price \$
SP-1812	4545695001346	1/4" Screwgun • 205mm long • 800rpm • 6.35mm capacity • 304L/min max, 213L/min av air consumption • 1.2kg	



1/4" Impact Screwgun

Model No.	Barcode	Description/Features	Price \$
SP-8102B	4545695000943	1/4" Impact Screwgun • 152mm long • 11500rpm • 6.35mm capacity • 647L/min max, 324L/min av air consumption • 1.1kg	



SP Impact driven Screwdrivers are high performance assembly tools. They come with 1/4" hex female quick change chucks for simple bit change overs. A positive action trigger to control speed and a handle exhaust which keeps air away from the work area. It also features an impact type twin hammer mechanism for balanced high torque and continuous operation.



7" Polisher

Model No.	Barcode	Description/Features	Price \$
SP-1247	4545695301087	7" Polisher • 405mm long • 3800rpm • 178mm capacity • 608L/min max, 365L/min av air consumption • 2.4kg	



7" Sander

Model No.	Barcode	Description/Features	Price \$
SP-1245	4545695001681	7" Sander • 406mm long • 5000rpm • 178mm capacity • 808L/min max, 730L/min av air consumption • 2.86kg	



5" Disc Sander

Model No.	Barcode	Description/Features	Price \$
SP-1350	4545695001599	5" Disc Sander • 155mm long • 15000rpm • 125mm capacity • 808L/min max, 730L/min av air consumption • 1.0kg	



2" Gasket Sander

Model No.	Barcode	Description/Features	Price \$
SP-1330H	4545695001100	2" Gasket Sander • 125mm long • 12000rpm • 50mm capacity • 469L/min max, 330L/min av air consumption • 0.67kg	



Full range of gasket sanding discs, pads etc available on page 43

10mm Belt Sander

Model No.	Barcode	Description/Features	Price \$
SP-1370	4545695300639	10mm Belt Sander <ul style="list-style-type: none"> • 275mm long • 16000rpm • 10x330mm capacity • 647L/min max, 583L/min av air consumption • 0.8kg 	

20mm Belt Sander

Model No.	Barcode	Description/Features	Price \$
SP-1380	4545695300646	20mm Belt Sander <ul style="list-style-type: none"> • 365mm long • 17000rpm • 20x520mm capacity • 852L/min max, 766L/min av air consumption • 1.4kg 	

2.5mm Orbital Sander

Model No.	Barcode	Description/Features	Price \$
SP-3600	9330514014349	2.5mm Orbital Sander <ul style="list-style-type: none"> • 225mm long • 10000rpm • 150mm capacity • 448L/min max, 403L/min av air consumption • 0.95kg 	

5mm Orbital Sander

Model No.	Barcode	Description/Features	Price \$
SP-3605	9330514005262	5mm Orbital Sander <ul style="list-style-type: none"> • 225mm long • 10000rpm • 150mm capacity • 448L/min max, 403L/min av air consumption • 0.95kg 	

SP Random Orbital Sanders are available in both dust extraction and non-dust extraction models, bar handle and palm type grips. The dust extraction models can be used as self vacuum units or can be hooked up to a dust extractor with the SP hose adaptor.



100mm (4") Lever Angle Grinder (Automotive)

Model No.	Barcode	Description/Features	Price \$
SP-2254	9330514006504	100mm (4") Lever Angle Grinder (Automotive) <ul style="list-style-type: none"> • 225mm long • 11000rpm • 100mm capacity • 566L/min max, 509L/min av air consumption • 1.72kg 	



125mm (5") Lever Angle Grinder (Automotive)

Model No.	Barcode	Description/Features	Price \$
SP-2257	9330514006511	125mm (5") Lever Angle Grinder (Automotive) <ul style="list-style-type: none"> • 225mm long • 11000rpm • 125mm capacity • 566L/min max, 509L/min av air consumption • 1.76kg 	



100mm (4") Lever Angle Grinder (Industrial)

Model No.	Barcode	Description/Features	Price \$
SP-1254	4545695001148	100mm (4") Lever Angle Grinder (Industrial) <ul style="list-style-type: none"> • 229mm long • 12000rpm • 100mm capacity • 566L/min max, 509L/min av air consumption • 1.7kg 	



125mm (5") Lever Angle Grinder (Industrial)

Model No.	Barcode	Description/Features	Price \$
SP-1257	4545695001155	125mm (5") Lever Angle Grinder (Industrial) <ul style="list-style-type: none"> • 229mm long • 12000rpm • 125mm capacity • 566L/min max, 509L/min av air consumption • 1.7kg 	



180mm (7") Lever Angle Grinder (Industrial)

Model No.	Barcode	Description/Features	Price \$
SP-1261	4545695000912	180mm (7") Lever Angle Grinder (Industrial) <ul style="list-style-type: none"> • 340mm long • 7500rpm • 180mm capacity • 910L/min max, 819L/min av air consumption • 3.8kg 	



Chisel Gun (Automotive)

Model No.	Barcode	Description/Features	Price \$
SP-2410	9330514006559	Chisel Gun <ul style="list-style-type: none"> • 170mm long • 3500bpm • 10.2mm capacity • 350L/min max, 245L/min av air consumption • 1.44kg 	



Chisel Gun (Industrial)

Model No.	Barcode	Description/Features	Price \$
SP-1410	4545695000851	Chisel Gun <ul style="list-style-type: none"> • 216mm long • 3800bpm • 10.2mm capacity • 404L/min max, 283L/min av air consumption • 1.65kg 	



<p>MODEL: CHI-SP1 Spring Retainer Chisel</p> 	<p>MODEL: D06 Wide Scraper Chisel</p> 	<p>MODEL: D23 Flat Blade Chisel</p> 
	<p>MODEL: D59 Panel Cutter Chisel</p> 	<p>MODEL: D60 Rivet and Bolt Cutter Chisel</p> 

Chisel gun accessories on page 40

Scaler

Model No.	Barcode	Description/Features	Price \$
SP-1470	4545695001186	Scaler <ul style="list-style-type: none"> • 410mm long • 4000bpm • 3mm needles • 605L/min max, 424L/min av air consumption • 2.6kg 	

Scaler needles on page 68



P3MMN 3mm needles

Air Nibbler

Model No.	Barcode	Description/Features	Price \$
SP-2215	9330514006566	Air Nibbler <ul style="list-style-type: none"> • 185mm long • 1.6mm steel cutting capacity • 1.2mm stainless steel cutting capacity • 470L/min max, 179L/min av • 1.02kg 	



Straight Air Saw

Model No.	Barcode	Description/Features	Price \$
SP-1730	4545695000813	Straight Air Saw <ul style="list-style-type: none"> • 240mm long • 5000 strokes p/min • 1.5mm cutting capacity • 360L/min max, 252L/min av • 1.15kg 	

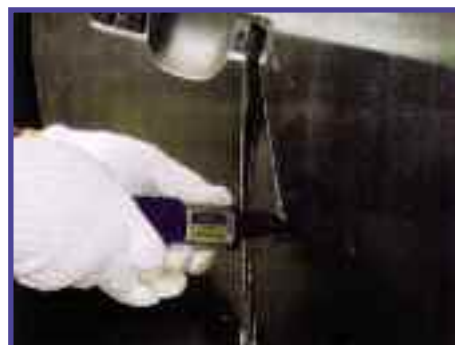

MODEL: SAW-B100
Pack of 4 Hacksaw Blades
 • 32 teeth
 • For cutting steel



MODEL: SAW-C100
Pack of 4 Hacksaw Blades
 • 24 teeth
 • For cutting aluminium



MODEL: SAW-W100
Pack of 4 Hacksaw Blades
 • 14 teeth
 • For cutting wood/urethane



Optional blades on page 42

© Copyright 2010. All prices exclude GST

Chisel Gun Accessories

Model No.	Barcode	Description/Features	Price \$
D06	9330514001219	Wide Scraper Chisel • 170mm long • 50mm tip	
D23	9330514001226	Flat Blade Chisel • 170mm long • 20mm tip	
D59	9330514001233	Panel Cutter Chisel • 170mm long • Panel cutter tip	
D60	9330514003251	Rivet and Belt Cutter Chisel • 170mm long • 20mm tip	
CHI-SPI	9330514001202	• Spring Retainer Chisel	

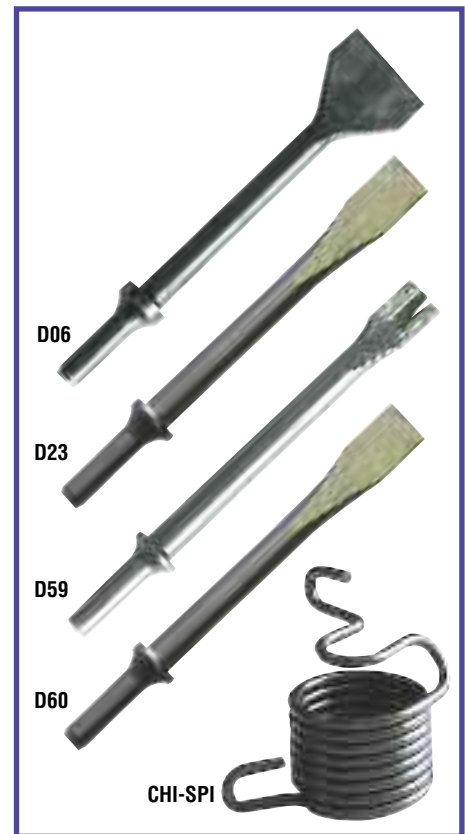

Drill Chucks/Keys

Model No.	Barcode	Description/Features	Price \$
DLC-9	9330514002711	• 3/8" x 3/8" x 24tpi Key Type Drill Chuck	
DLC-10	9330514001189	• 3/8" x 3/8" x 24tpi Keyless Drill Chuck	
DLC-13	9330514002728	• 1/2" x 3/8" x 24tpi Key Type Drill Chuck	
DLC-15	9330514002735	• 1/2" x 3/8" x 20tpi Key Type Drill Chuck	
DLC-17	9330514001196	• 1/2" x 1/2" x 20tpi Keyless Drill Chuck	
DCK-2	9330514002742	• 3/8" Chuck Key	
DCK-3	9330514004678	• 1/2" Chuck Key	



Chuck Key



Keyless Type Drill Chucks

Air Hacksaw Blades (Packs of 4)

Model No.	Barcode	Description/Features	Price \$
SAW-B100	9330514001271	Pack of 4 Hacksaw Blades <ul style="list-style-type: none"> • 32 Teeth • For Cutting Steel 	
SAW-C100	9330514001288	Pack of 4 Hacksaw Blades <ul style="list-style-type: none"> • 24 Teeth • For Cutting Aluminium 	
SAW-W100	9330514003268	Pack of 4 Hacksaw Blades <ul style="list-style-type: none"> • 14 Teeth • For Cutting Wood/Urethane 	

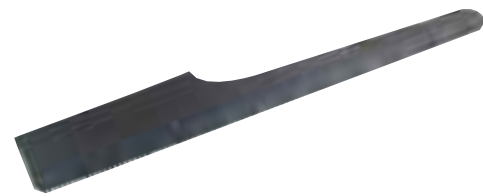

Die Grinder Collets

Model No.	Barcode	Description/Features	Price \$
C127-4	9330514001240	• 1/4" Collet	
C127-6	9330514001257	• 6mm Collet	
C127-8	9330514001264	• 1/8" Collet	



Accessories

Model No.	Barcode	Description/Features	Price \$
MOL-21	9330514001301	• Mini Oiler	
SC-910A	9330514001318	• Swivel Connector	
RG-30	9330514001295	• Inline Regulator	

MOL-21



Mini Oiler

SC-910A



Swivel Connector

RG-30



Inline Regulator

Sanding Pads

Model No.	Barcode	Description/Features	Price \$
PD-215	9330514004722	5" Sanding Pad • Suits SP-1222SD Type Super Sanders	
PD-245P	9330514004746	7" Sanding Pad • Suits SP-1245 Sander • Plastic Moulded Type	
PD-6E	9330514001325	6" Sanding Pad • Suits D/A Sanders • PSA Type	
PD-6EV	9330514001332	6" Sanding Pad • Suits D/A Sanders • Velcro Type	
PD-6H	9330514001349	6" Sanding Pad • Suits D/A Sanders • Dust Free • PSA Type	
PD-6HV	9330514001356	6" Sanding Pad • Suits D/A Sanders • Dust Free • Velcro Type	



Sanding Pads

Model No.	Barcode	Description/Features	Price \$
SP-2053	9330514001042	Pack of 4 Course Discs • For use on Cast Iron Cylinder Heads	
SP-2053B	9330514001066	Box of 50 Course Discs • For use on Cast Iron Cylinder Heads	
SP-2051	9330514001059	Pack of 4 Fine Discs • For use on Aluminium Cylinder Heads	
SP-2051B	9330514001073	Box of 50 Fine Discs • For use on Aluminium Cylinder Heads	
SP-205A	9330514001028	2" Gasket Sander Pad & Spindle	
SP-205D	9330514001035	Gasket Removal Kit • Includes Pad and Spindle, 2 x course discs and 2 x fine discs	



Long Nozzle Air Duster

Model No.	Barcode	Description/Features	Price \$
SP-111	9330514000922	<ul style="list-style-type: none"> • Plastic lever • Brass Inlet • Length 100mm 	



Long Nozzle Air Duster

Model No.	Barcode	Description/Features	Price \$
SP-113	9330514004807	<ul style="list-style-type: none"> • Plastic lever • Brass Inlet • Length 750mm 	

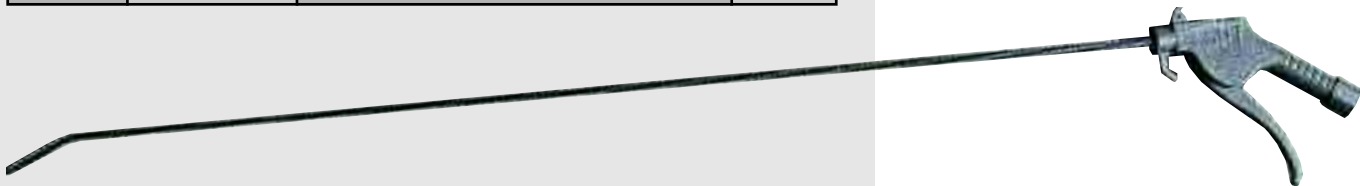

Cylinder Burr

Model No.	Barcode	Description/Features	Price \$
SP31350	9330514020050	<ul style="list-style-type: none"> • 10mm x 20mm 	

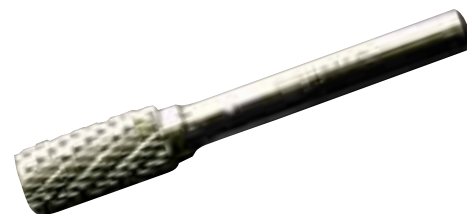

Cylinder with Radius Top Burr

Model No.	Barcode	Description/Features	Price \$
SP31351	9330514020067	<ul style="list-style-type: none"> • 10mm x 20mm 	

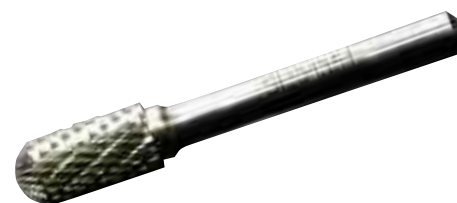

Ball Burr

Model No.	Barcode	Description/Features	Price \$
SP31360	9330514020081	<ul style="list-style-type: none"> • 8mm Diameter 	



Tree with Radius Top Burr

Model No.	Barcode	Description/Features	Price \$
SP31365	9330514020098	<ul style="list-style-type: none"> • 10mm x 25mm 	



**Scorpion Superior Air –
Australia's own generation of
compressors and air tools.**

**Designed and developed in
co-operation with Australian industry, our
product development team uses a 3 tier design strategy of durability,
efficiency and value for money. Scorpion boasts an extensive range
covering industry sectors, ranging from automotive mechanics to
manufacturing.**

**We guarantee our products for superior quality, reliability and
efficiency. When performance counts, you can count on Scorpion.**

- Compressors - direct drive, belt drive and petrol driven
- Low, high, gravity and suction fed spray guns
- Comprehensive range of air tools
- Air fittings manufactured from high quality brass and steel



Scorpion nailers



Quality you can count on

10 Bar Pressure Cordless Inflator/Compressor

Model No.	Barcode	Description/Features	Price \$
SS25	9330514005439	10 Bar Pressure Cordless Inflator/Compressor <ul style="list-style-type: none"> • Cordless air compressor • 12v charger with car adaptor & 240v charger • Nozzle for inflating footballs • Flexible nozzle • Nozzle for inflating car wheels • Nozzle for inflating bicycle and motorcycle wheels 	



1.5hp Direct Drive Air Compressor

Model No.	Barcode	Description/Features	Price \$
SS65	9330514005040	1.5hp Direct Drive Air Compressor <ul style="list-style-type: none"> • Direct drive • 52L/min FAD • 125psi • 6lt tank • 240Volts/10amp • Regulator 	



2hp Portable Air Compressor

Model No.	Barcode	Description/Features	Price \$
S11-25	9330514020012	2hp Portable Air Compressor <ul style="list-style-type: none"> • Direct drive • 127L/min FAD • 125psi • 25lt tank • 240Volts/10amp • Regulator 	



Alloy Portable Air Compressors

Model No.	Barcode	Description/Features	Price \$
XRS1350	9330514016367	2.2hp Alloy Portable Air Compressor <ul style="list-style-type: none"> • Belt drive • 169L/min FAD • 150psi • 50lt tank • 240Volts/10amp • Filter/regulator 	
XRS1750	9330514016374	3hp Alloy Portable Air Compressor <ul style="list-style-type: none"> • Belt drive • 254L/min FAD • 150psi • 50lt tank • 240Volts/10amp • Filter/regulator 	



Twin Cast Iron Belt Drive Portable Air Compressor

Model No.	Barcode	Description/Features	Price \$
XRV14	9330514023914	2.5hp Cast Iron V-Twin Portable Air Compressor <ul style="list-style-type: none"> • Belt drive • 225L/min FAD • 150psi • 50lt tank • 240Volts/10amp • Filter/regulator 	
XRV17	9330514021323	3hp Cast Iron V-Twin Portable Air Compressor <ul style="list-style-type: none"> • Belt drive • 251L/min FAD • 150psi • 50lt tank • 240Volts/10amp • Filter/regulator 	



Twin Cast Iron Belt Drive Portable Air Compressor

Model No.	Barcode	Description/Features	Price \$
XRV1700	9330514022405	3hp Cast Iron Portable Air Compressor <ul style="list-style-type: none"> • Belt drive • 251L/min FAD • 150psi • 100lt tank • 240Volts/10amp • Filter/regulator 	



Triple Cast Iron Belt Drive Portable Air Compressor

Model No.	Barcode	Description/Features	Price \$
XRS18	9330514016381	3hp Triple Cast Iron Portable Air Compressor <ul style="list-style-type: none"> • Belt drive • 309L/min FAD • 150psi • 60lt tank • 240Volts/10amp • Filter/regulator 	



Triple Cast Iron Belt Drive Portable Air Compressor

Model No.	Barcode	Description/Features	Price \$
XRS1800	9330514021248	Triple Cast Iron Portable Air Compressor <ul style="list-style-type: none"> • Belt drive • 309L/min FAD • 150psi • 100lt tank • 240Volts/10amp • Filter/regulator 	



Twin Cast Iron Stationary Air Compressor

Model No.	Barcode	Description/Features	Price \$
XRS25	9330514003718	5.5hp Electric Stationary Air Compressor <ul style="list-style-type: none"> • Belt drive • 482L/min FAD • 152psi • 200lt tank • 415Volts/10amp • Filter/regulator • Includes wheel package • 1460 x 480 x 1150mm 	
XRS33	9330514036532	7.5hp Electric Stationary Air Compressor <ul style="list-style-type: none"> • 2 stage belt drive • 700L/min FAD • 152psi • 200lt tank • 415Volts/10amp • 1460 x 480 x 1150mm 	



Triple Cast Iron Stationary Air Compressor

Model No.	Barcode	Description/Features	Price \$
XRS35	9330154003725	7.5hp Electric Stationary Air Compressor <ul style="list-style-type: none"> • Belt drive • 704L/min FAD • 152psi • 270lt tank • 415Volts/15amp • 1560 x 540 x 1140mm 	
XRS50	9330514003732	10hp Electric Stationary Air Compressor <ul style="list-style-type: none"> • Belt drive • 1085L/min FAD • 152psi • 270lt tank • 415Volts/18amp • 1560 x 540 x 1150mm 	



Petrol Air Compressor

Model No.	Barcode	Description/Features	Price \$
XRV1760P	9330514021255	6.5hp Portable Air Compressor <ul style="list-style-type: none"> • Belt drive • 376L/min FAD • 150psi • 60lt tank • 415Volts/15amp • Filter/regulator • Torini OHV 4 stroke engine • V-Twin Cast iron pump 	



Workshop Package

Model No.	Description/Features	Price \$
WP25	Workshop Package <ul style="list-style-type: none"> • XRS25 air compressor • LD05SHA air dryer • JF-A-001 micron filter • JF-C-001 micron filter 	



Workshop Package

Model No.	Description/Features	Price \$
WP35	Workshop Package <ul style="list-style-type: none"> • XRS35 air compressor • LD10SHA air dryer • JF-A-002 micron filter • JF-C-002 micron filter 	



Workshop Package

Model No.	Description/Features	Price \$
WP50	Workshop Package <ul style="list-style-type: none"> • XRS50 air compressor • LD10SHA air dryer • JF-A-002 micron filter • JF-C-002 micron filter 	



Pressure Switches

Model No.	Barcode	Description/Features	Price \$
SCA5001	9330514007228	4 Port Pressure Switch <ul style="list-style-type: none"> To suit all single phase compressors 240volt 	
3013268	4014502225201	MDR2/1100 Type Pressure Switch <ul style="list-style-type: none"> 240volt 	
3031106	4014502228370	MDR3/10 Type Pressure Switch <ul style="list-style-type: none"> To suit 5.5hp compressors 415volt 	
3031107	401450228394	MDR3/16 Type Pressure Switch <ul style="list-style-type: none"> To suit 7.5hp compressors 415volt 	
3031108	401450228394	MDR3/20 Type Pressure Switch <ul style="list-style-type: none"> To suit 10hp compressors 415volt 	



Non Return Valves

Model No.	Barcode	Description/Features	Price \$
SCA1004	9330514007150	1/2" bsp Non Return Valve	
NRV3/4	9330514004418	3/4" bsp Non Return Valve	



Air Valve

Model No.	Barcode	Description/Features	Price \$
SCA3002	9330514007167	Air Valve <ul style="list-style-type: none"> 1/4" bsp 	



Drain Cock

Model No.	Barcode	Description/Features	Price \$
SCA4002	93301514007174	Drain Cock <ul style="list-style-type: none"> 1/4" bsp 	



Winged Drain Cocks

Model No.	Barcode	Description/Features	Price \$
SCA4002A-4	9330514007181	1/4" bsp Winged Drain Cock	
SCA4002A-2	9330514007198	1/2" bsp Winged Drain Cock	



Ring Drain Cock

Model No.	Barcode	Description/Features	Price \$
SCA4002A-2R	9330514020005	Ringed Drain Cock <ul style="list-style-type: none"> 1/2" bsp 	



Pressure Release Valves

Model No.	Barcode	Description/Features	Price \$
SCA2002-8	9330514007129	1/4" bsp 8 Bar Pressure Release Valve	
SCA2002-110	9330514007136	1/4" bsp 10 Bar Pressure Release Valve	
SCA2002-210	9330514007143	1/2" bsp 10 Bar Pressure Release Valve	



Gauges

Model No.	Barcode	Description/Features	Price \$
SCA20S	9330514007204	50mm x 1/4" bsp Bottom Mount Gauge	
SCA20R	9330514007211	50mm x 1/4" bsp Rear Mount Gauge	
330006000	9330514023938	40mm x 1/4" bsp Rear Mount Gauge	



Filter Regulators

Model No.	Barcode	Description/Features	Price \$
SFR-202	9330514022085	1/4" Mini Filter Regulator <ul style="list-style-type: none"> • 25 micron filter • 550L/min rated flow • Set pressure: 8-125psi • Manual drain 	
SFR-302	9330514022009	1/4" Filter Regulator <ul style="list-style-type: none"> • 25 micron filter • 2000L/min rated flow • Set pressure: 8-125psi • Air shutoff drain 	
SFR-404	9330514022108	1/2" Filter Regulator <ul style="list-style-type: none"> • 25 micron filter • 4000L/min rated flow • Set pressure: 8-125psi • Air shutoff drain 	



Filter

Model No.	Barcode	Description/Features	Price \$
SF-404	9330514022115	1/2" Filter <ul style="list-style-type: none"> • 25 micron filter • 4000L/min rated flow • Air shutoff drain 	



Regulator

Model No.	Barcode	Description/Features	Price \$
SR-404	9330514022139	1/2" Regulator <ul style="list-style-type: none"> • 6000L/min rated flow • Set pressure: 8-125psi 	



Lubricator

Model No.	Barcode	Description/Features	Price \$
SL-404	9330514022122	1/2" Inline Lubricator <ul style="list-style-type: none"> • Temperature range: 5-600c • 5000L/min rated flow 	



Alloy Belt Drive Pumps

Model No.	Barcode	Description/Features	Price \$
MK102	9330514022276	Alloy Pump with Cast Iron Cylinders • Head unloading valve • 150psi	
MK103	9330514022283	Alloy Pump with Cast Iron Cylinders • Head unloading valve • 150psi	



Twin Cast Iron Belt Drive Pumps

Model No.	Barcode	Description/Features	Price \$
SKM11	9330514022290	2.2hp Compressor Pump	
SKM13	9330514022306	3hp Compressor Pump	
SKM13S	9330514022313	3hp Compressor Pump	
SKM14	9330514004333	3hp Compressor Pump	
SKM15	9330514022320	5.5hp Compressor Pump • 150psi	



Triple Cast Iron Belt Drive Pumps

Model No.	Barcode	Description/Features	Price \$
SKM16	9330514004340	7.5hp Compressor Pump	
SKM18	9330514004357	10hp Compressor Pump • 150psi	



240V Electric Motors

Model No.	Barcode	Description/Features	Price \$
CEM-2	9330514022221	2.2hp Fini Electric 240v Motor (10amp)	
CEM-3	9330514022238	3hp Fini Electric 240v Motor (15amp) • 50Hz/240v • Single capacitor • Shaft 19mm	



415V Electric Motors

Model No.	Barcode	Description/Features	Price \$
CEM-5.5	9330514022245	5.5hp Fini Electric Motor • 10amp/415v, 3 phase	
CEM-7.5	9330514022252	7.5hp Fini Electric Motor • 15amp/415v, 3 phase	
CEM-10	9330514022269	10hp Fini Electric Motor • 18amp/415v, 3 phase	



3/8" Mini Ratchet Wrench

Model No.	Barcode	Description/Features	Price \$
SX-323	933014001110	3/8" Mini Ratchet Wrench <ul style="list-style-type: none"> • 180mm long • 230rpm • 10mm bolt capacity • 141L/min average air consumption • 30ft/lbs torque • 0.56kg 	



1/2" Ratchet Wrench

Model No.	Barcode	Description/Features	Price \$
SX-336	9330514006269	1/2" Ratchet Wrench <ul style="list-style-type: none"> • 227mm long • 170rpm • 13mm bolt capacity • 110L/min average air consumption • 50ft/lbs torque • 1.22kg 	

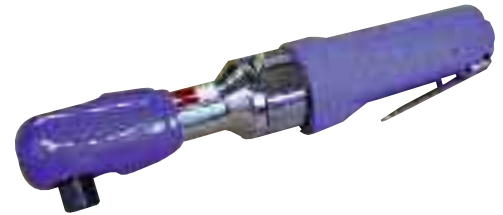

1/2" Ratchet Wrench

Model No.	Barcode	Description/Features	Price \$
SX-335	9330514006262	1/2" Ratchet Wrench <ul style="list-style-type: none"> • 260mm long • 200rpm • 13mm bolt capacity • 170L/min average air consumption • 55ft/lbs torque • 1.18kg 	



1/4" & 3/8" Through Ratchet

Model No.	Barcode	Description/Features	Price \$
SX-350	9330514006856	1/4" & 3/8" Through Ratchet <ul style="list-style-type: none"> • 210mm long • 10mm bolt capacity • 85L/min average air consumption • 30ft/lbs torque • 0.68kg 	



Dual Anvil

**COMES WITH
DUAL ANVIL & INSERT
SOCKETS**



Insert
Sockets

3/8" Palm Type Impact Wrench

Model No.	Barcode	Description/Features	Price \$
SX-210	9330514002629	3/8" Palm Type Impact Wrench <ul style="list-style-type: none"> • 10mm bolt capacity • 150L/min average air consumption • 70ft/lbs torque • 0.98kg 	



3/8" Pistol Type Impact Wrench

Model No.	Barcode	Description/Features	Price \$
SX-211	9330514001080	3/8" Pistol Type Impact Wrench <ul style="list-style-type: none"> • 10mm bolt capacity • 160L/min average air consumption • 70ft/lbs torque • 1.22kg 	



1/2" Impact Wrench

Model No.	Barcode	Description/Features	Price \$
SX-225	9330514002636	1/2" Impact Wrench <ul style="list-style-type: none"> • 180mm long • 16mm bolt capacity • 190L/min average air consumption • 280ft/lbs torque • 2.42kg 	



1/2" Composite Body Impact Wrench

Model No.	Barcode	Description/Features	Price \$
SX-229	9330514005705	1/2" Composite Body Impact Wrench <ul style="list-style-type: none"> • 195mm long • 18mm capacity • 260L/min average air consumption • 600ft/lbs (forward), 850ft/lbs (reverse) torque • 1.92kg 	



3/4" Composite Body Impact Wrench

Model No.	Barcode	Description/Features	Price \$
SX-259	9330514020777	3/4" Composite Body Impact Wrench <ul style="list-style-type: none"> • 230mm long • 29mm capacity • 215L/min average air consumption • 950ft/lbs (forward), 1200ft/lbs (reverse) torque • 3.5kg 	



3/8" High Speed Drill

Model No.	Barcode	Description/Features	Price \$
SX-529	9330514006221	3/8" High Speed Drill <ul style="list-style-type: none"> • 150mm long • 5000rpm • 400L/min max, 280L/min av air consumption • 0.74kg 	



3/8" Angle Head Reversible Drill

Model No.	Barcode	Description/Features	Price \$
SX-535	9330514002650	3/8" Angle Head Reversible Drill <ul style="list-style-type: none"> • 208mm long • 1500rpm • 450L/min max, 315L/min av air consumption • 1.12kg 	



3/8" Straight Drill

Model No.	Barcode	Description/Features	Price \$
SX-590	9330514003169	3/8" Straight Drill <ul style="list-style-type: none"> • 210mm long • 2500rpm • 9.5mm capacity • 450L/min max, 315L/min av air consumption • 0.96kg 	

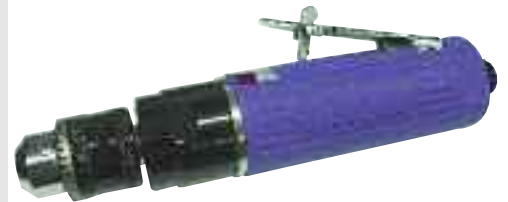

3/8" Reversible Pistol Drill

Model No.	Barcode	Description/Features	Price \$
SX-530	9330514002667	3/8" Reversible Pistol Drill <ul style="list-style-type: none"> • 190mm long • 1800rpm • 9.5mm capacity • 530L/min max, 371L/min av air consumption • 1.16kg • Keyless chuck 	



1/2" Reversible Pistol Drill

Model No.	Barcode	Description/Features	Price \$
SX-538	9330514002841	1/2" Reversible Pistol Drill <ul style="list-style-type: none"> • 210mm long • 1800rpm • 12.7mm capacity • 530L/min max, 371L/min av air consumption • 1.96kg • Keyless chuck 	



1/4" Straight Die Grinder

Model No.	Barcode	Description/Features	Price \$
SX-201	9330514002889	1/4" Straight Die Grinder <ul style="list-style-type: none"> • 175mm long • 22000rpm • 1/4" collet capacity • 590L/min max, 413L/min av air consumption • 0.76kg 	



1/4" Extended Die Grinder

Model No.	Barcode	Description/Features	Price \$
SX-203	9330514006252	1/4" Extended Die Grinder <ul style="list-style-type: none"> • 282mm long • 20000rpm • 1/4" collet capacity • 460L/min max, 322L/min av air consumption • 0.96kg 	



1/4" Angle Head Die Grinder

Model No.	Barcode	Description/Features	Price \$
SX-202	9330514002896	1/4" Angle Head Die Grinder <ul style="list-style-type: none"> • 155mm long • 18000rpm • 1/4" collet capacity • 460L/min max, 322L/min av air consumption • 0.64kg 	



4" Mini Heavy Duty Angle Grinder

Model No.	Barcode	Description/Features	Price \$
SX-249	9330514006238	4" Mini Heavy Duty Angle Grinder <ul style="list-style-type: none"> • 190mm long • 13000rpm • 100mm capacity • 400L/min max, 360L/min av air consumption • 1.06kg 	



4" Lever Throttle Angle Grinder

Model No.	Barcode	Description/Features	Price \$
SX-250	9330514002858	4" Lever Throttle Angle Grinder <ul style="list-style-type: none"> • 230mm long • 11000rpm • 100mm capacity • 580L/min max, 52L/min av air consumption • 1.88kg 	



6" Random Orbital Sander

Model No.	Barcode	Description/Features	Price \$
SX-310	9330514002865	6" Random Orbital Sander <ul style="list-style-type: none"> • 10000rpm • 150mm capacity • 910L/min max, 819L/min av air consumption • 1.97kg 	



1/3 Sheet Sander

Model No.	Barcode	Description/Features	Price \$
SX-300	9330514003176	1/3 Sheet Sander <ul style="list-style-type: none"> • 8000rpm • 89x197mm capacity • 342L/min max, 171L/min av air consumption • 1.86kg 	



10mm x 330mm Belt Sander

Model No.	Barcode	Description/Features	Price \$
SX-271	9330514002872	10mm x 330mm Belt Sander <ul style="list-style-type: none"> • 16000rpm • 10x330mm capacity • 655L/min max, 590L/min av air consumption • 0.94kg 	



20mm x 520mm Belt Sander

Model No.	Barcode	Description/Features	Price \$
SX-281	9330514005323	20mm x 520mm Belt Sander <ul style="list-style-type: none"> • 16000rpm • 20x520mm capacity • 880L/min max, 792L/min av air consumption • 1.24kg 	



Chisel Gun

Model No.	Barcode	Description/Features	Price \$
SX-711	9330514002926	Chisel Gun <ul style="list-style-type: none"> • 3000bpm • 0.401 shank capacity • 402L/min max, 281L/min av air consumption • 2.10kg 	



Shear

Model No.	Barcode	Description/Features	Price \$
SX-500	9330514005330	Shear <ul style="list-style-type: none"> • 2200rpm • 1.6mm steel capacity • 530L/min max, 371L/min av air consumption • 1.22kg 	



Air Saw

Model No.	Barcode	Description/Features	Price \$
SX-313	9330514002919	Air Saw <ul style="list-style-type: none"> • 10000 strokes p/min (no load) • 1.6mm steel capacity • 320L/min max, 224L/min av air consumption • 10mm stroke length • 0.68kg 	



Air Riveters

Model No.	Barcode	Description/Features	Price \$
TAR-40	9330514001790	3/16" Pistol Type Pop Riveter <ul style="list-style-type: none"> • 4.8mm (3/16") max capacity • 90psi pressure • 3/16", 5/32", 1/8", 3/32" tip sizes • 1870lbs traction • 1.4L/stroke air consumption • 1.64kg 	
TAR-45	9330514001806	1/4" Pistol Type Pop Riveter <ul style="list-style-type: none"> • 6.35mm (1/4") max capacity • 90psi pressure • 1/4", 3/16", 5/32", 1/8", 3/32" tip sizes • 3080lbs traction • 2.8L/stroke air consumption • 2.20kg 	



Needle Scaler

Model No.	Barcode	Description/Features	Price \$
SX-175	9330514002933	Needle Scaler <ul style="list-style-type: none"> • 4000brpm • 19x3mm needles • 460L/min max, 230L/min av air consumption • 2.92kg 	



Needle Scaler

Model No.	Barcode	Description/Features	Price \$
SXJ-16	9330514005651	Needle Scaler <ul style="list-style-type: none"> • 250mm long • 4000brpm • 29x2mm needles • 200L/min max, 100L/min av air consumption • 1.60kg 	



Composite Body Needle Scaler

Model No.	Barcode	Description/Features	Price \$
SXJ-20	9330514005668	Composite Body Needle Scaler <ul style="list-style-type: none"> • 320mm long • 4000brpm • 12x3mm needles • 400L/min max, 200L/min av air consumption • 2.36kg 	



Needle Scaler

Model No.	Barcode	Description/Features	Price \$
SXJ-28	9330514005675	Needle Scaler <ul style="list-style-type: none"> • 360mm long • 4500brpm • 28x3mm needles • 500L/min max, 250L/min av air consumption • 3.62kg 	

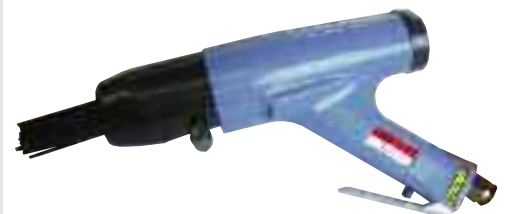

Needle Scaler

Model No.	Barcode	Description/Features	Price \$
SXJ-268	9330514005682	Needle Scaler <ul style="list-style-type: none"> • 410mm long • 4400brpm • 19x3mm needles • 500L/min max, 250L/min av air consumption • 2.88kg 	



Needle Scaler

Model No.	Barcode	Description/Features	Price \$
SXJ-110	9330514005699	Needle Scaler <ul style="list-style-type: none"> • 320mm long • 3700brpm • 19x3mm needles • 400L/min max, 200L/min av air consumption • 2.90kg 	



Touch-Up Gun

Model No.	Barcode	Description/Features	Price \$
SX-30	9330514005347	Touch-Up Gun <ul style="list-style-type: none"> • 0.25lt pot size • 50psi pressure • 85L/min max, 77L/min av air consumption • 0.44kg • 1.6mm nozzle size 	



Low Pressure Spray Gun

Model No.	Barcode	Description/Features	Price \$
SX-20	9330514005354	Low Pressure Spray Gun <ul style="list-style-type: none"> • 0.8lt pot size • 10-40psi pressure • 115L/min max, 103L/min av air consumption • 0.64kg • 1.3mm nozzle size 	



1lt High Pressure Spray Gun

Model No.	Barcode	Description/Features	Price \$
SX60-2	9330514002698	1lt High Pressure Spray Gun <ul style="list-style-type: none"> • 1lt pot size • 50psi pressure • 312L/min max, 280L/min av air consumption • 1.22kg • 1.8mm nozzle size 	



1lt High Pressure Spray Gun

Model No.	Barcode	Description/Features	Price \$
S-770	9330514003503	1lt High Pressure Spray Gun <ul style="list-style-type: none"> • 1lt pot size • 60psi pressure • 298L/min max air consumption • 1.06kg • 2mm nozzle size 	



High Pressure Paint Tank

Model No.	Barcode	Description/Features	Price \$
SX-77	9330514007914	10lt Spray Tank with Pressure Gauge & Adjusting Valve <ul style="list-style-type: none"> • 10lt pot size • 50psi pressure • 320L/min max, 295L/min av air consumption • 17.5kg • 1.8mm nozzle size 	
SX-78	9330514011164	20lt Spray Tank with Pressure Gauge & Adjusting Valve <ul style="list-style-type: none"> • 20lt pot size • 50psi pressure • 320L/min max, 295L/min av air consumption • 24kg • 1.8mm nozzle size 	



2lt High Pressure Spray Gun with Pot

Model No.	Barcode	Description/Features	Price \$
SX-70	9330514005361	2lt High Pressure Spray Gun with Pot <ul style="list-style-type: none"> • 2lt pot size • 50psi pressure • 315L/min max, 281L/min av air consumption • 2mm nozzle size • 2.60kg 	



Touch-Up Gravity Fed Spray Gun

Model No.	Barcode	Description/Features	Price \$
SX-40	9330514011140	0.8mm Touch-Up Gravity Fed Spray Gun <ul style="list-style-type: none"> • 120ml pot size • 10-30psi pressure • 169L/min max, 98L/min av air consumption • 0.44kg 	



High Pressure Gravity Fed Spray Guns

Model No.	Barcode	Description/Features	Price \$
SX50-1	9330514002674	1.4mm Nozzle Gravity Fed Spray Gun <ul style="list-style-type: none"> • 600ml pot size • 50psi pressure • 285L/min max, 256L/min av air consumption • 0.86kg 	
SX50-3	9330514002681	2mm Nozzle Gravity Fed Spray Gun <ul style="list-style-type: none"> • 600ml pot size • 50psi pressure • 285L/min max, 256L/min av air consumption • 0.86kg 	



HVLP Gravity Fed Spray Guns

Model No.	Barcode	Description/Features	Price \$
SX90-1	9330514003466	1.4mm Nozzle HVLP Spray Gun <ul style="list-style-type: none"> • 600ml pot size • 15-50psi pressure • 218L/min max, 196L/min av air consumption • 1.14kg 	
SX90-3	9330514003473	2mm Nozzle HVLP Spray Gun <ul style="list-style-type: none"> • 600ml pot size • 15-50psi pressure • 218L/min max, 196L/min av air consumption • 1.14kg 	



Gravity Fed Spray Gun Kit

Model No.	Barcode	Description/Features	Price \$
SX-55	9330514011157	3pc Gravity Fed Spray Gun Kit <ul style="list-style-type: none"> • SX-40 touch up gun (0.8mm nozzle size) • SX50-1 spray gun (1.4mm nozzle size) • Pressure gauge 	

Combination Nail & Stapler

Model No.	Barcode	Description/Features	Price \$
S1850C	9330514005507	Combination Nail & Stapler <ul style="list-style-type: none"> • 255mm long • 60-90psi pressure • "C1" series nails 15-50mm, "90" series staples 16-40mm • Includes carry case 	



16mm Staple Gun

Model No.	Barcode	Description/Features	Price \$
S8016	9330514005521	16mm Staple Gun <ul style="list-style-type: none"> • 225mm long • 60-100psi pressure • "80" series styles, 12.9mm crown, 3-16mm length • 160pc load capacity 	



16 Gauge Finish Nailer

Model No.	Barcode	Description/Features	Price \$
S1650	9330514005538	16mm Gauge Finish Gun <ul style="list-style-type: none"> • 310mm long • 60-100psi pressure • "C" series brad nails 15-50mm • 100pc load capacity • 50mm fastener capacity 	



Framing Gun

Model No.	Barcode	Description/Features	Price \$
S9034	9330514005514	Framing Gun <ul style="list-style-type: none"> • 468mm long • 70-120psi pressure • 34° D or clipped hand nails 50-90mm • 56-70pc load capacity • 90mm fastener capacity 	



Angle Finish Nailer

Model No.	Barcode	Description/Features	Price \$
SDA64	9330514016442	Angle Finish Nailer <ul style="list-style-type: none"> • 350mm long • 60-100psi pressure • 32-64mm/15 gauge • 80pc load capacity 	



T-Nailer

Model No.	Barcode	Description/Features	Price \$
S64B	9330514005545	T-Nailer <ul style="list-style-type: none"> • 225mm long • 65-115psi pressure • 2.2mm² T nails 18-64mm • 100pc load capacity • 64mm fastener capacity 	



Hose Reel with 30m Hose

Model No.	Barcode	Description/Features	Price \$
HR-30	9330514000748	Hose Reel with 30m Hose <ul style="list-style-type: none"> • 1/4" air inlet and outlet • All metal construction hose reel • Rotary base hose reel • 7.68kg 	



Hose Reel with 30m Hose

Model No.	Barcode	Description/Features	Price \$
RHR-15	9330514005446	15m Auto Retractable Air Hose Reel <ul style="list-style-type: none"> • 10mm PVC hose • 1/4" BSP fittings • Heavy duty clamp shell construction • 7.32kg 	



Air Hoses

Model No.	Barcode	Description/Features	Price \$
A66-15	9330514003213	10mm x 15m Air Hose with No Fittings	
A66-20	9330514014097	10mm x 20m Air Hose with No Fittings	
A66-30	9330514014080	10mm x 30m Air Hose with No Fittings	
A66-300	9330514004517	10mm x 300m Air Hose with No Fittings	



Fitted Air Hoses with Nitto Type Fittings

Model No.	Barcode	Description/Features	Price \$
I66-15N	9330514005385	10mm x 15m Air Hose with Nitto Type Fittings	
I66-20N	9330514014073	10mm x 20m Air Hose with Nitto Type Fittings	
I66-30N	9330514013991	10mm x 30m Air Hose with Nitto Type Fittings	



Fitted Air Hoses with Ryco Type Fittings

Model No.	Barcode	Description/Features	Price \$
I66-15R	9330514005392	10mm x 15m Air Hose with Ryco Type Fittings	
I66-20R	9330514014103	10mm x 20m Air Hose with Ryco Type Fittings	
I66-30R	9330514014110	10mm x 30m Air Hose with Ryco Type Fittings	



Recoil Hoses

Model No.	Barcode	Description/Features	Price \$
SX-806	9330514012604	6m Recoil Hose <ul style="list-style-type: none"> • 1/4" BSP fittings 	
SX-809	9330514012628	9m Recoil Hose <ul style="list-style-type: none"> • 1/4" BSP fittings 	
SX-815	9330514012611	15m Recoil Hose <ul style="list-style-type: none"> • 1/4" BSP fittings 	



Hi Flow Series Interchange Nitto Type Male Plug

Model No.	Barcode	Description/Features	Box	Price \$
PM20	9330514003244	1/4" Male Thread Plug	Box 10	
PM30	9330514005156	3/8" Male Thread Plug	Box 10	
PM40	9330514002759	1/2" Male Thread Plug	Box 10	



(Box 10)

Hi Flow Series Interchange Nitto Type Female Plug

Model No.	Barcode	Description/Features	Box	Price \$
PF20	9330514002766	1/4" Female Thread Plug	Box 10	
PF30	9330514005163	3/8" Female Thread Plug	Box 10	
PF40	9330514002773	1/2" Female Thread Plug	Box 10	



(Box 10)

Hi Flow Series Interchange Nitto Type Hose Tail Plug

Model No.	Barcode	Description/Features	Box	Price \$
PH20	9330514002780	1/4" Barbed Hose Tail	Box 10	
PH30	9330514001158	3/8" Barbed Hose Tail	Box 10	
PH40	9330514001172	1/2" Barbed Hose Tail	Box 10	



(Box 10)

Hi Flow Series Interchange Nitto Type Male Socket

Model No.	Barcode	Description/Features	Box	Price \$
SM20	9330514001165	1/4" Male Thread Socket	Box 5	
SM30	9330514004838	3/8" Male Thread Socket	Box 5	
SM40	9330514002797	1/2" Male Thread Socket	Box 5	



(Box 5)

Hi Flow Series Interchange Nitto Type Female Socket

Model No.	Barcode	Description/Features	Box	Price \$
SF20	9330514002803	1/4" Female Thread Socket	Box 5	
SF30	9330514002810	3/8" Female Thread Socket	Box 5	
SF40	9330514002827	1/2" Female Thread Socket	Box 5	



(Box 5)

Hi Flow Series Interchange Nitto Type Hose Tail Socket

Model No.	Barcode	Description/Features	Box	Price \$
SH20	9330514004845	1/4" Hose Tail Socket	Box 5	
SH30	9330514001141	3/8" Hose Tail Socket	Box 5	
SH40	9330514002834	1/2" Hose Tail Socket	Box 5	



(Box 5)

104 Series Interchange Ryco Type Fittings

Model No.	Barcode	Description/Features	Box	Price \$
A104-1	9330514005002	1/4" Female Thread Coupler	Box 5	
A104-2	9330514003220	1/4" Female Barb	Box 10	
A104-3	9330514003237	1/4" Male Barb	Box 10	
A104-4	9330514001134	3/8" Hose Tail Barb	Box 10	
A104-11	9330514005019	1/4" Male Thread Coupler	Box 5	
A104-12	9330514001127	1/4" Hose Tail Coupler	Box 5	



105 Series Interchange Jamec Type Fittings

Model No.	Barcode	Description/Features	Box	Price \$
A105-1	9330514005026	1/4" Female Thread Coupler	Box 5	
A105-2	9330514005071	1/4" Female Barb	Box 10	
A105-3	9330514005088	1/4" Male Barb	Box 10	
A105-4	9330514005095	3/8" Hose Tail Barb	Box 10	
A105-11	9330514005033	1/4" Male Thread Coupler	Box 5	
A105-12	9330514005064	1/4" Hose Tail Coupler	Box 5	

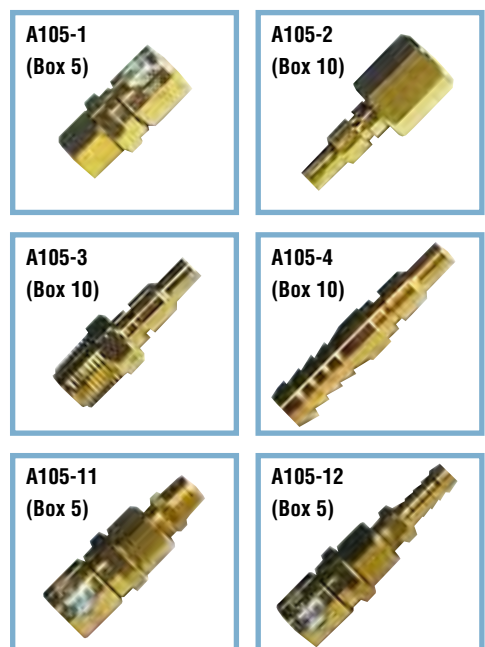

Brass Air Fittings

Model No.	Barcode	Description/Features	Price \$
SCA52	9330514013717	1/4" M x 1/4" F Hex Socket	
SCA12	9330514013724	1/4" M x 1/4" M Hex Nipple	
SCA102-7	9330514013731	1/4" Female Tee	
SCA63	9330514013748	1/4" F x 3/8" M Reducing Brush	
SCA63A	9330514013755	1/4" F x 1/2" M Reducing Brush	
SCA19	9330514013762	1/4" F x 3/8" Hose Tail	
SCA19A	9330514013779	1/4" F x 1/2" Hose Tail	
SCA112	9330514022177	5 Way Connector	



Hi Flow Series Interchange Nitto Type Male Plugs

Model No.	Barcode	Description/Features	Price \$
PM20C	9330514000038	1/4" Male Thread Plug Nitto Type • 1pc per pack	
PM30C	9330514000045	3/8" Male Thread Plug Nitto Type • 1pc per pack	
PM40C	9330514000052	1/2" Male Thread Plug Nitto Type • 1pc per pack	



Hi Flow Series Interchange Nitto Type Female Plugs

Model No.	Barcode	Description/Features	Price \$
PF20C	9330514000069	1/4" Female Thread Plug Nitto Type • 1pc per pack	
PF30C	9330514000076	3/8" Female Thread Plug Nitto Type • 1pc per pack	
PF40C	9330514000083	1/2" Female Thread Plug Nitto Type • 1pc per pack	



Hi Flow Series Interchange Nitto Type Hose Tail Plugs

Model No.	Barcode	Description/Features	Price \$
PH20C	9330514000090	1/4" Hose Tail & Hose Clamp Nitto Type • 1pc per pack	
PH30C	9330514000106	3/8" Hose Tail & Hose Clamp Nitto Type • 1pc per pack	
PH40C	9330514000113	1/2" Hose Tail & Hose Clamp Nitto Type • 1pc per pack	



Hi Flow Series Interchange Nitto Type Male Socket

Model No.	Barcode	Description/Features	Price \$
SM20C	9330514000120	1/4" Male Thread Socket Nitto Type • 1pc per pack	
SM30C	9330514000137	3/8" Male Thread Socket Nitto Type • 1pc per pack	
SM40C	9330514000144	1/2" Male Thread Socket Nitto Type • 1pc per pack	



Hi Flow Series Interchange Nitto Type Female Socket

Model No.	Barcode	Description/Features	Price \$
SF20C	9330514000151	1/4" Female Thread Socket Nitto Type • 1pc per pack	
SF30C	9330514000168	3/8" Female Thread Socket Nitto Type • 1pc per pack	
SF40C	9330514000175	1/2" Female Thread Socket Nitto Type • 1pc per pack	



Hi Flow Series Interchange Nitto Type Hose Tail Socket

Model No.	Barcode	Description/Features	Price \$
SH20C	9330514000182	1/4" Hose Tail Socket & Hose Clamp Nitto Type • 1pc per pack	
SH30C	9330514000199	3/8" Hose Tail Socket & Hose Clamp Nitto Type • 1pc per pack	
SH40C	9330514000205	1/2" Hose Tail Socket & Hose Clamp Nitto Type • 1pc per pack	



104 Series Interchange Ryco Type Fittings

Model No.	Barcode	Description/Features	Price \$
A104-1C	9330514000304	1/4" Female Thread Coupler • 1pc per pack	
A104-2C	9330514000335	1/4" Female Thread Plug • 2pc per pack	
A104-3C	9330514000342	1/4" Male Thread Plug • 2pc per pack	
A104-4C	9330514000359	3/8" Hose Tail Plug & Hose Clamp • 1pc per pack	
A104-11C	9330514000311	1/4" Male Thread Coupler • 1pc per pack	
A104-12C	9330514000328	3/8" Hose Tail Coupler & Hose Clamp • 1pc per pack	

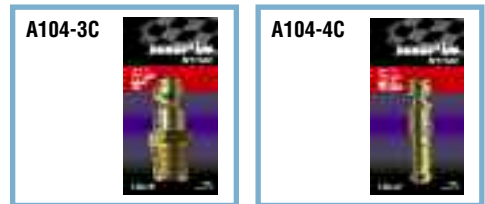

105 Series Interchange Jamec Type Fittings

Model No.	Barcode	Description/Features	Price \$
A105-1C	9330514000366	1/4" Female Thread Socket • 1pc per pack	
A105-2C	9330514000397	1/4" Female Thread Plug • 2pc per pack	
A105-3C	9330514000403	1/4" Male Thread Plug • 2pc per pack	
A105-4C	9330514000410	3/8" Hose Tail Barb & Hose Clamp • 1pc per pack	
A105-11C	9330514000373	1/4" Male Thread Socket • 1pc per pack	
A105-12C	9330514000380	3/8" Hose Tail Socket & Hose Clamp • 1pc per pack	

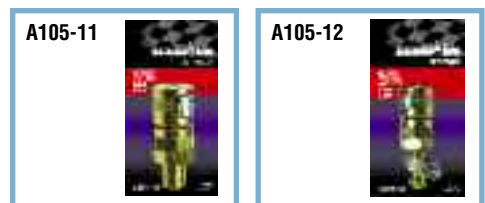

Tyre Chucks

Model No.	Barcode	Description/Features	Price \$
TC-9080	9330514022146	Straight Hold On Tyre Chuck	
TC-9081	9330514022153	Angle Clip On Tyre Chuck	
TC-9084	9330514001004	Dual Head 1/4" Inlet Tyre Chuck	
TC-9085	9330514001011	Dual Head 1/4" Inlet Tyre Chuck Rubber Grip	
TC-9086	9330514022160	Hold On Tyre Chuck with Hose	



Tyre Inflator

Model No.	Barcode	Description/Features	Price \$
S-900	9330514000731	Tyre Inflator • Tyre inflator and deflator • Dial gauge • High quality hose and fittings • Trade quality	



Through Ratchet Sockets

Model No.	Barcode	Description/Features	Price \$
350-10	9330514006863	10mm Insert Socket	
350-12	9330514006870	12mm Insert Socket	
350-13	9330514006887	13mm Insert Socket	
350-14	9330514006894	14mm Insert Socket	

Scaler Needles

Model No.	Barcode	Description/Features	Price \$
P2MNN	9330514007570	2mm Dia Individual Needles	
P3MNN	9330514006276	3mm Dia Individual Needles	

Suction Fed Spray Pots

Model No.	Barcode	Description/Features	Price \$
SX-77P	9330514003510	1lt Bayonette Style Spray Gun Pot • To suit SX60-2 and SW77-2 spray guns	
SX-77PSCREW	9330514022061	1lt Screw Style Spray Gun Pot • To suit SX60-2 and SW77-2 spray guns	



Gravity Fed Spray Pots

Model No.	Barcode	Description/Features	Price \$
SX-40P	9330514022078	120ml Spray Gun Pot • To suit SX-40 spray guns	
SX-50P	9330514003190	600ml Spray Gun Pot • To suit SX50-1, SX50-3, SX90-1 and SX90-3 spray guns	



C Series Finishing Nails

Model No.	Barcode	Description/Features	Price \$
C25	9330514005965	C Series 16 Gauge 25mm Finishing Nails • Pack of 1600	
C32	9330514005972	C Series 16 Gauge 32mm Finishing Nails • Pack of 800	
C35	9330514005989	C Series 16 Gauge 35mm Finishing Nails • Pack of 800	
C38	9330514005996	C Series 16 Gauge 38mm Finishing Nails • Pack of 800	
C45	9330514006009	C Series 16 Gauge 45mm Finishing Nails • Pack of 800	
C50	9330514006016	C Series 16 Gauge 50mm Finishing Nails • Pack of 800 • Suits S1650 16 gauge finishing gun	



C1 Series Finishing Nails

Model No.	Barcode	Description/Features	Price \$
C115	9330514006023	C1 Series 18 Gauge 15mm Finishing Nails • Pack of 3600	
C120	9330514006030	C1 Series 18 Gauge 20mm Finishing Nails • Pack of 2400	
C125	9330514006047	C1 Series 18 Gauge 25mm Finishing Nails • Pack of 2400	
C132	9330514006054	C1 Series 18 Gauge 32mm Finishing Nails • Pack of 1200	
C135	9330514006061	C1 Series 18 Gauge 35mm Finishing Nails • Pack of 1200	
C138	9330514006078	C1 Series 18 Gauge 38mm Finishing Nails • Pack of 1200 • Suits S1850C nail and staple gun	



80 Series Staples

Model No.	Barcode	Description/Features	Price \$
8006	9330514005903	80 Series 6mm Staples • Pack of 2000	
8008	9330514005910	80 Series 8mm Staples • Pack of 2000	
8010	9330514005927	80 Series 10mm Staples • Pack of 1000	
8012	9330514005934	80 Series 12mm Staples • Pack of 1000	
8014	9330514005941	80 Series 14mm Staples • Pack of 1000	
8016	9330514005958	80 Series 16mm Staples • Pack of 1000 • Suits S8016 staple gun	

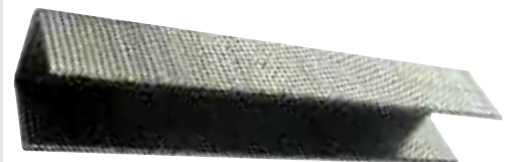

90 Series Staples

Model No.	Barcode	Description/Features	Price \$
9016	9330514006085	90 Series 16mm Staples • Pack of 1200	
9019	9330514006092	90 Series 19mm Staples • Pack of 800	
9022	9330514006108	90 Series 22mm Staples • Pack of 800	
9025	9330514006115	90 Series 25mm Staples • Pack of 800	
9032	9330514006122	90 Series 32mm Staples • Pack of 400	
9040	9330514006139	90 Series 40mm Staples • Pack of 400 • Suits S1850C nail and staple gun	

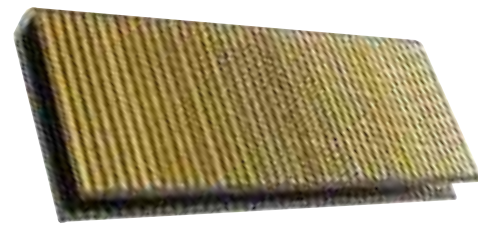

Framing Nails 34 Degree

Model No.	Barcode	Description/Features	Price \$
50287	9330514006146	50mm Framing Nails • Pack of 1000	
75305	9330514006153	75mm Framing Nails • Pack of 1000	
75305B	9330514007815	75mm Framing Nails • Pack of 3000 • Suits S9034 framing gun • 34 degree • Paper collated	



Angle Finishing Nails 34 Degree

Model No.	Barcode	Description/Features	Price \$
DA38	9330514007594	38mm Angle Finish Nails • Pack of 1000	
DA50	9330514007600	50mm Angle Finish Nails • Pack of 1000	
DA64	9330514007617	64mm Angle Finish Nails • Pack of 1000 • Suits SDA64 framing gun	



Finishing T-Nails

Model No.	Barcode	Description/Features	Price \$
ST-25	9330514005842	25mm Finishing T-Nails • Pack of 400	
ST-32	9330514005859	32mm Finishing T-Nails • Pack of 400	
ST-38	9330514005866	38mm Finishing T-Nails • Pack of 200	
ST-45	9330514005873	45mm Finishing T-Nails • Pack of 200	
ST-50	9330514005880	50mm Finishing T-Nails • Pack of 200	
ST-64	9330514005897	64mm Finishing T-Nails • Pack of 200 • Suits S64B t-nailer	



Coil Nails

Model No.	Barcode	Description/Features	Price \$
CN65-35	9330514005774	35mm Length Plain Nails <ul style="list-style-type: none"> • 300pcs per roll • 2 rolls per carton 	
CN65-45	9330514005781	45mm Length Plain Nails <ul style="list-style-type: none"> • 300pcs per roll • 2 rolls per carton 	
CN65-45G	9330514005774	45mm Length Plain Galvanised Nails <ul style="list-style-type: none"> • 300pcs per roll • 2 rolls per carton 	
CN65-45R	9330514005804	45mm Length Plain Ring Nails <ul style="list-style-type: none"> • 300pcs per roll • 2 rolls per carton 	
CN65-45S	9330514005828	45mm Length Plain Screw Nails <ul style="list-style-type: none"> • 300pcs per roll • 2 rolls per carton 	
CN65-65	9330514006931	65mm Length Plain Nails <ul style="list-style-type: none"> • 300pcs per roll • 2 rolls per carton 	
CN65-65R	9330514005811	65mm Length Plain Ring Nails <ul style="list-style-type: none"> • 300pcs per roll • 2 rolls per carton 	
CN65-65S	9330514005839	65mm Length Plain Screw Nails <ul style="list-style-type: none"> • 300pcs per roll • 2 rolls per carton • Suits S65 coil nailer 	

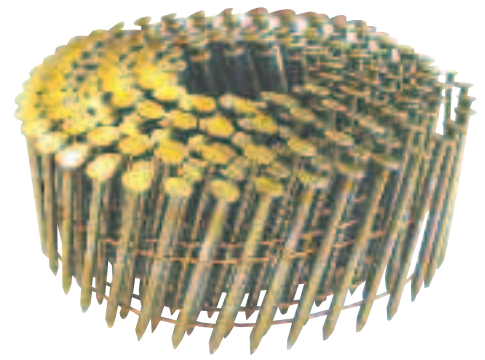



SRT Air – the brand trusted by more home workshops.

SRT offers the best value for any proposition when it comes to light duty trade tools and compressors.

Drawing on our extensive knowledge in air products, we ensure that SRT Tools and Compressors will deliver reliable performance at a competitive price.

For all your DIY projects, look to the brand you can count on to get the job done - SRT Air.



Engine cleaning gun

72 Austech Price List, 2010



Reliable kits

© Copyright 2010. All prices exclude GST

2hp Direct Drive Air Compressor

Model No.	Barcode	Description/Features	Price \$
SRT-1024	9330514021156	2hp Electric Portable Air Compressor <ul style="list-style-type: none"> • Direct drive • 115psi • 24lt tank • 10amp/240volt • 70L/min P/Disp 	



2.5hp Direct Drive Air Compressor

Model No.	Barcode	Description/Features	Price \$
SRT-1040	9330514021163	2.5hp Electric Portable Air Compressor <ul style="list-style-type: none"> • Direct drive • 115psi • Regulator • 40lt tank • 10amp/240volt • 121L/min P/Disp 	



2.2hp Belt Drive Air Compressor

Model No.	Barcode	Description/Features	Price \$
SRT-2240	9330514007808	2.2hp Portable Air Compressor <ul style="list-style-type: none"> • Belt drive • 115psi • Filter/regulator • 40lt tank • 15amp/240volt • 162L/min P/Disp • 149L/min FAD 	



Direct Drive Air Compressor Kit

Model No.	Barcode	Description/Features	Price \$
SRT-1024K	9330514021170	Direct Drive Air Compressor Kit <ul style="list-style-type: none"> • SRT-1024 2hp electric portable air compressor • Recoil air hose • Air duster • Tyre inflator 	



Belt Drive Air Compressor Kit

Model No.	Barcode	Description/Features	Price \$
SRT-2240K	9330514022184	Belt Drive Air Compressor Kit <ul style="list-style-type: none"> • SRT-2240 2.2hp portable air compressor • PTK-1000 pit lane tool kit 	



1/2" Ratchet Wrench

Model No.	Barcode	Description/Features	Price \$
SRT-502	9330514005569	1/2" Ratchet Wrench <ul style="list-style-type: none"> • 200rpm • 158L/min average air consumption • 50ft/lbs torque • 1.22kg 	



1/2" Impact Wrench

Model No.	Barcode	Description/Features	Price \$
SRT-504	9330514005453	1/2" Impact Wrench <ul style="list-style-type: none"> • 550bpm • 190L/min average air consumption • 260ft/lbs torque • 2.18kg 	



3/8" Reverse Drill

Model No.	Barcode	Description/Features	Price \$
SRT-503	933051407013	3/8" Reverse Drill <ul style="list-style-type: none"> • 1800rpm • 380L/min average air consumption • 9.5mm capacity • 2.18kg • Keyless chuck 	



1/4" Die Grinder

Model No.	Barcode	Description/Features	Price \$
SRT-508	933051407020	1/4" Die Grinder <ul style="list-style-type: none"> • 175mm long • 22000rpm • 380L/min average air consumption • 6.35mm capacity • 2.18kg 	



Caulking Gun

Model No.	Barcode	Description/Features	Price \$
SRT-7040	9330514000632	Caulking Gun <ul style="list-style-type: none"> • Borex tube length 2" x 8 1/2" • 170L/min average air consumption • 0.90kg 	



Engine Cleaner with Pot

Model No.	Barcode	Description/Features	Price \$
SRT-5000	9330514000625	Engine Cleaner with Pot <ul style="list-style-type: none"> • 0.64kg 	



Tyre Inflators

Model No.	Barcode	Description/Features	Price \$
SRT-6001A	9330514007921	Tyre Inflator with Pop Out Brass Gauge <ul style="list-style-type: none"> Economy model 	
SRT-7002	9330514000724	Compact 3 Function Tyre Inflator and Deflator <ul style="list-style-type: none"> Easy to read dial gauge Quality hose and fittings Compact design 	



Sand Blaster

Model No.	Barcode	Description/Features	Price \$
SRT-4071	9330514000618	Sand Blaster <ul style="list-style-type: none"> 2mm nozzle size 2m siphon hose length 1.54kg Includes 3 spare nozzles 	



Air Brush

Model No.	Barcode	Description/Features	Price \$
SRT-8808	93305140005637	Air Brush <ul style="list-style-type: none"> 140mm long 2 x 50ml pots 600mm hose 0.12kg 	



Accessory Kit

Model No.	Barcode	Description/Features	Price \$
AK-5	9330514000557	5pc Air Accessory Kit <ul style="list-style-type: none"> Spray gun Washing gun Tyre inflator Air duster Air hose 	



Inflator Kit

Model No.	Barcode	Description/Features	Price \$
AK-6	9330514000507	6pc Inflator Kit <ul style="list-style-type: none"> Air duster Tyre inflator Air hose 3 inflator nozzles 	



Impact Wrench Kit

Model No.	Barcode	Description/Features	Price \$
SRT-6004	9330514000458	1/2" Impact Wrench Kit • 1/2" impact wrench • Impact sockets • Carry case	



Die Grinder Kit

Model No.	Barcode	Description/Features	Price \$
SRT-8033K	9330514000472	Die Grinder Kit • Die grinder • Grinding stones • Carry case	



Chisel Gun Kit

Model No.	Barcode	Description/Features	Price \$
SRT-3012KR	9330514000519	Chisel Gun Kit • 3000bpm chisel gun • 5 chisels • Carry case	



Pit Lane Tool Kit

Model No.	Barcode	Description/Features	Price \$
PTK-1000	9330514000564	Pit Lane Tool Kit • 1/2"dr impact wrench, sockets and mini oiler in a carry case • 3/8"dr reverse drill • Spray gun • Degreasing gun • Tyre inflator • Air duster • 15m hose and all quick fit couplers	



Merchandisers

Air Tool Stand



Nail & Staple Stand



Merchandisers

Air Fitting Stand



Generator Stand - Small or Large



Index

8006	69	C127-6	42	JF-A-007	17	S11-25	46
8008	69	C127-8	42	JF-C-001	17	S1650	62
8010	69	C132	69	JF-C-002	17	S1850C	62
8012	69	C135	69	JF-C-007	17	S-3600HM	8
8014	69	C138	69	LC-5	12	S-3700HM	8
8016	69	C150	69	LC-7	12	S64B	62
9016	70	C25	69	LC-8	12	S-770	60
9019	70	C32	69	LC-9	12	S8016	62
9022	70	C35	69	LD05SHA	17	S-900	68
9025	70	C38	69	LD10SHA	17	S9034	62
9032	70	C45	69	LD15SHA	17	SAW-B100	42
9040	70	C50	69	LD20SHA	17	SAW-C100	42
50287	70	CEM-10	52	LD50SHA	17	SAW-W100	42
75305	70	CEM-2	52	MCI40	16	SC1200	5
3013268	50	CEM-3	52	MCI50	16	SC-910A	42
3031106	50	CEM-5.5	52	MK102	52	SC960	5
3031107	50	CEM-7.5	52	MK103	52	SCA1004	50
3031108	50	CHI-SP1	41	MOL-21	42	SCA102-7	65
330006000	51	CN65-35	71	NRV3/4	50	SCA112	65
350-10	68	CN65-45	71	NZ-10B	12	SCA12	65
350-12	68	CN65-45G	71	NZ-10G	12	SCA19	65
350-13	68	CN65-45R	71	NZ-10R	12	SCA19A	65
350-14	68	CN65-45S	71	NZ-10W	12	SCA2002-110	51
A104-1	65	CN65-65	71	NZ-10Y	12	SCA2002-210	51
A104-11	65	CN65-65R	71	NZ-8B	12	SCA2002-8	51
A104-11C	67	CN65-65S	71	NZ-8G	12	SCA20R	51
A104-12	65	D06	41	NZ-8R	12	SCA20S	51
A104-12C	67	D23	41	NZ-8W	12	SCA3002	50
A104-1C	67	D4	8	NZ-8Y	12	SCA4002	50
A104-2	65	D59	41	P2MNN	68	SCA4002A-2	50
A104-2C	67	D6	8	P3MMN	68	SCA4002A-2R	50
A104-3	65	D60	41	PCK-10	13	SCA4002A-4	50
A104-3C	67	DA38	70	PD-215	43	SCA5001	50
A104-4	65	DA50	70	PD-6E	43	SCA52	65
A104-4C	67	DA64	70	PD-6EV	43	SCA63	65
A105-1	65	DCK-2	41	PD-6H	43	SCA63A	65
A105-11	65	DCK-3	41	PD-6HV	43	SDA64	62
A105-11C	67	DLC-10	41	PF20	64	SDI1000	5
A105-12	65	DLC-13	41	PF20C	66	SDI2000E	5
A105-12C	67	DLC-15	41	PF30	64	SF20	64
A105-1C	67	DLC-17	41	PF30C	66	SF20C	66
A105-2	65	DLC-9	41	PF40	64	SF30	64
A105-2C	67	DN-6	13	PF40C	66	SF30C	66
A105-3	65	DN-8	13	PH20	64	SF40	64
A105-3C	67	FB-10	13	PH20C	66	SF-404	51
A105-4	65	FB-7	13	PH30	64	SF40C	66
A105-4C	67	HR-30	63	PH30C	66	SFR-202	51
A66-15	63	HS-10-20	13	PH40	64	SFR-302	51
A66-20	63	HS-10C	13	PH40C	66	SFR-404	51
A66-30	63	HS-5	13	PLUS30	16	SH20	64
A66-300	63	HS-7	13	PM20	64	SH20C	66
AK-5	75	HS-8	13	PM20C	66	SH30	64
AK-6	75	HS-9	13	PM30	64	SH30C	66
BFKN	14	I66-15N	63	PM30C	66	SH40	64
BSC10270L	16	I66-15R	63	PM40	64	SH40C	66
BSC15270L	16	I66-20N	63	PM40C	66	SKM11	52
BSC20270L	16	I66-20R	63	PTK-1000	76	SKM13	52
C115	69	I66-30N	63	PW1000	5	SKM13S	52
C120	69	I66-30R	63	RB-10	13	SKM14	52
C125	69	JF-A-001	17	RG-30	42	SKM15	52
C127-4	42	JF-A-002	17	RHR15	63	SKM16	52

Index

SKM18	52	SP-1810	35	SRT-2240	73	SX-55	61
SL2800	6	SP-1812	35	SRT-2240K	73	SX-590	55
SL3500	6	SP-1826	25	SRT-3012KR	76	SX60-2	60
SL-404	51	SP-1850	25	SRT-4071	75	SX-70	61
SL5600	6	SP-2051	43	SRT-5000	74	SX-711	58
SL6800	6	SP-2051B	43	SRT-502	74	SX-77	60
SL6800E	6	SP-2053	43	SRT-503	74	SX-77P	68
SM20	64	SP-2053B	43	SRT-504	74	SX-77PSCREW	68
SM20C	66	SP-205A	43	SRT-508	74	SX-78	60
SM30	64	SP-205D	43	SRT-6001A	75	SX-806	63
SM30C	66	SP-2135	25	SRT-6004	76	SX-809	63
SM40	64	SP-2136	25	SRT-7002	75	SX-815	63
SM40C	66	SP-2200	30	SRT-7040	74	SX90-1	61
SP-111	44	SP-2200AH	31	SRT-8033K	76	SX90-3	61
SP11-10	19	SP-2215	40	SRT-8808	75	SXJ-110	59
SP-113	44	SP-2254	38	SS25	46	SXJ-16	59
SP-1133SX	24	SP-2257	38	SS65	46	SXJ-20	59
SP-1133SX-2	24	SP-2410	39	ST-25	70	SXJ-268	59
SP11-40	19	SP-2525	32	ST-32	70	SXJ-28	59
SP-1140EX	27	SP-2527	32	ST-38	70	TAR-40	58
SP-1140EXL	27	SP31350	44	ST-45	70	TAR-45	58
SP-1144EX	26	SP31351	44	ST-50	70	TC-9080	68
SP-1145A	26	SP31360	44	ST-64	70	TC-9081	68
SP-1145C	26	SP31365	44	SW2800	7	TC-9084	68
SP-1145L	26	SP-3600	37	SW3500	7	TC-9085	68
SP-1156TR	28	SP-3605	37	SW6800	7	TC-9086	68
SP-1158	28	SP-7131	24	SW6800E	7	TL-10	12
SP-1158L	28	SP-7140	27	SW8100E	7	TL-5	12
SP-1190-2	29	SP-7145	27	SWP200	14	TL-7	12
SP-1190-6	29	SP-7151	28	SX-175	59	TL-9	12
SP-1190-8	29	SP-7200	30	SX-20	60	TR200QE	3
SP-1190P	29	SP-7201	31	SX-201	56	TR340QE	3
SP-1192EX-2	29	SP-7202	31	SX-202	56	TR390QE	3
SP-1192EX-6	29	SP-7255	22	SX-203	56	TR420QE	3
SP-1207AH	31	SP-7525KL	33	SX-210	54	TRG-10	12
SP-1210	30	SP-7527KL	33	SX-211	54	TRG-5	12
SP-1245	36	SP-7742RH	22	SX-225	54	TRG-7	12
SP-1247	36	SP-7825	25	SX-229	54	TRG-8	12
SP12-50	19	SP-8102B	35	SX-249	56	TRG-9	12
SP-1254	38	SP-9171	20	SX-250	56	WP25	49
SP-1257	38	SP-9180	20	SX-259	54	WP35	49
SP-1261	38	SP-9190	20	SX-271	57	WP50	49
SP-1330H	36	SP-9200	21	SX-281	57	XRS1350	46
SP-1350	36	SP-9215	20	SX-30	60	XRS1750	46
SP13-50	19	SP-9225	20	SX-300	57	XRS18	47
SP-1370	37	SP-9250	21	SX-310	57	XRS1800	47
SP-1380	37	SP-9350	21	SX-313	58	XRS25	48
SP-1410	39	SP-9660	21	SX-323	53	XRS33	48
SP-1470	39	SPW112	10	SX-335	53	XRS35	48
SP-1510AH	34	SPW1300P	11	SX-336	53	XRS50	48
SP-1511	34	SPW141	10	SX-350	53	XRV14	47
SP-1522	34	SPW1500P	11	SX-40	61	XRV17	47
SP-1525	32	SPW2500P	11	SX-40P	68	XRV1700	47
SP-1527	32	SPW3600P	11	SX-500	58	XRV1760P	48
SP-1540	34	SPW383	10	SX50-1	61		
SP-1730	40	SPW4500P	11	SX50-3	61		
SP-1760A	22	SPW490	10	SX-50P	68		
SP-1762	22	SR-404	51	SX-529	55		
SP-1765	23	SRT-1024	73	SX-530	55		
SP-1772	22	SRT-1024K	73	SX-535	55		
SP-1800	35	SRT-1040	73	SX-538	55		

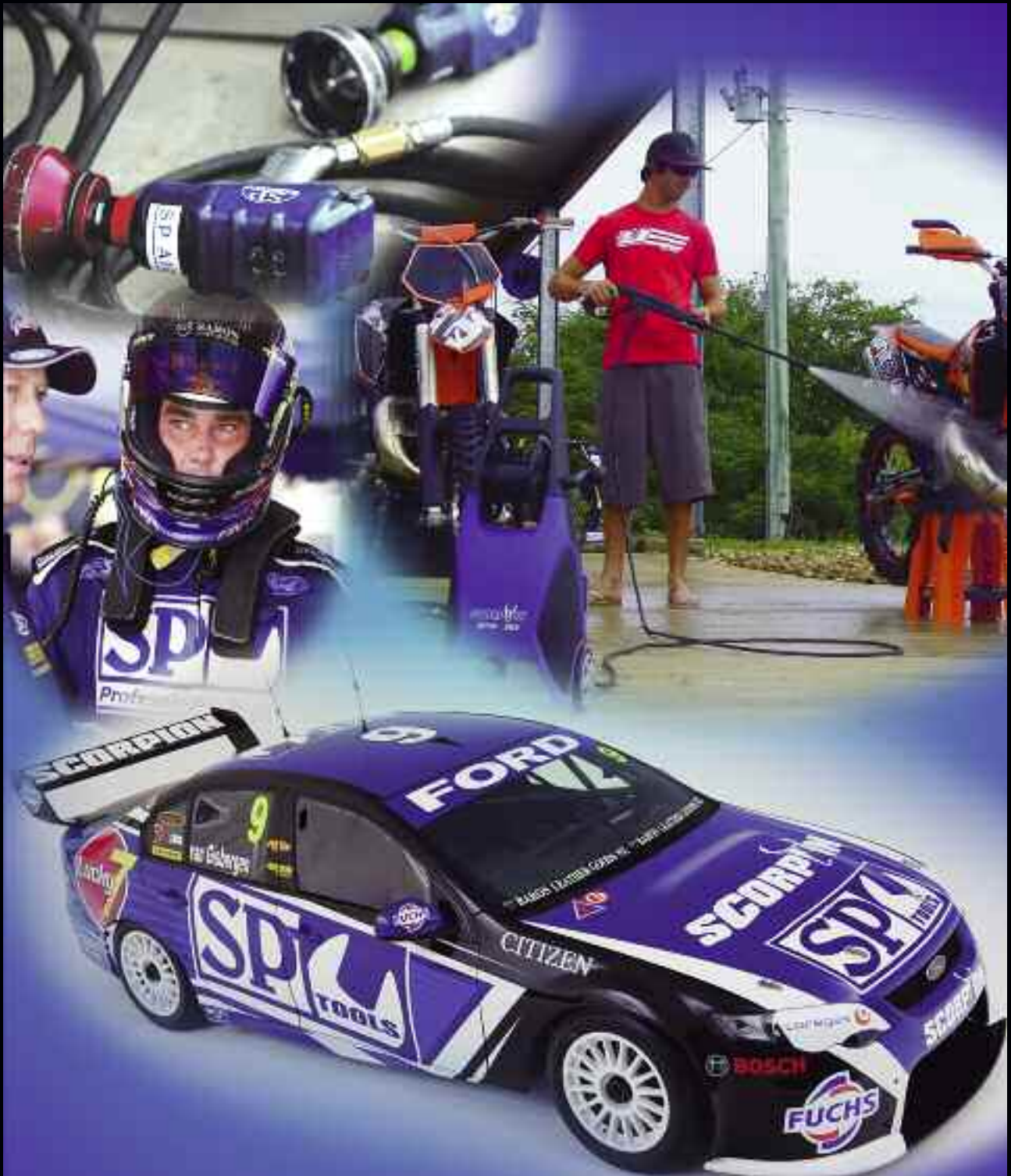

PL-AUS10

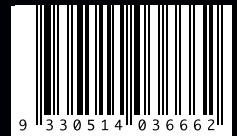

AUSTECH INDUSTRIES PTY LTD ACN 010 648 464

HEAD OFFICE
POSTAL ADDRESS:
 PO Box 715
 Archerfield QLD 4108
 Brisbane Australia

STREET ADDRESS:
 23 Iris Place
 Acacia Ridge Qld 4110
 Brisbane Australia

©COPYRIGHT

QUEENSLAND
 Ph: (07) 3723 1500
 Fax: (07) 3723 1555
 Email Sales:
 sales@austechindustries.com.au

NEW SOUTH WALES
 Ph: 0407 900 460 or 0433 430 580
 Fax: (02) 9545 6311
 Email Sales:
 sales@austechindustries.com.au

VICTORIA
 Ph: (03) 9706 6603
 Ph: (03) 9706 6608
 Email:
 sales.vic@austechindustries.com.au

TASMANIA
 Ph: (03) 6344 2686
 Fax: (03) 6344 7220
 Email Sales:
 sales@precons.com

SOUTH AUSTRALIA
 Ph: (08) 8260 6844
 Fax: (08) 8260 6660
 Email Sales:
 cjh@senet.com.au

WESTERN AUSTRALIA
 Ph: (08) 9351 9399
 Fax: (08) 9351 9366
 Email:
 sales.wa@austechindustries.com.au